

FLOW 38 BATCH

Ver.8.16

Installation and technical conditions

Date of issue 1/2/2016

Contents:

<i>Description of device</i>	Page 4
Scope of delivery	Page 4
<i>Storage conditions</i>	Page 5
<i>Warranty</i>	Page 5
<i>Installation in pipeline</i>	Page 6
Important information for selection of location.....	Page 6
Sources of interference	Page 6
Installation examples.....	Page 7
Actual installation in pipeline	Page 9
Installation check	Page 14
<i>Wiring</i>	Page 15
Important information.....	Page 15
Installation of meter detached evaluation unit.....	Page 16
Meter wiring of batching unit.....	Page 16
Meter wiring of sensor.....	Page 17
Impulse output / Flowswitch contact	Page 18
Buttons START, STOP.....	Page 18
Controlling of the batching valve.....	Page 19
Data output.....	Page 19
Protection degree.....	Page 19
Replacement of tube fuse in the meter.....	Page 19
Wiring check	Page 20
<i>Putting into operation</i>	Page 20
FLOW38 OPERATING INSTRUCTIONS	Page 21
Procedure to set individual menu items	Page 23
Date and Time	Page 24
Operation time counter	Page 24
Power loss counter	Page 24
Impulse output / Flowswitch ..	Page 25
Setting of the range of dose.....	Page 25
Communication.....	Page 26
Idle state basic indications on display	Page 26
Display dimming	Page 27
Display backlight	Page 27
Serial number.....	Page 27
Calibration constants	Page 27
Empty tube test	Page 27
Firmware version.....	Page 28
Dead band – measurement start suppression	Page 28
Zero calibration.....	Page 28
Flow simulation	Page 28
Language.....	Page 29

Counter resetting	Page 29
Nominal diameter (DN)	Page 29
Flow direction	Page 29
Flow units displayed [Q]	Page 30
Volume units displayed [V]	Page 30
Password change.....	Page 30
Default settings (original factory settings)	Page 30
<i>Technical data</i>	Page 32
<i>Factory settings</i>	Page 34
<i>Table with flow ranges for individual DN sizes</i>	Page 35
<i>Basic sensor sizes</i>	Page 36
<i>Nomogram for quick proposal of the measured place</i>	Page 39
<i>Reduction in DN pipe</i>	Page 39
<i>Faults and their symptoms during measurement</i>	Page 40
<i>Flow sensor cleaning</i>	Page 40
<i>Servicing</i>	Page 40
<i>Order code</i>	Page 41
<i>Form for shipment of the meter back to COMAC CAL s.r.o.</i>	Page 42

Description of device

The FLOW 38 Batch meter is based on measurement principle by a well-known Faraday's electromagnetic induction law according to which an electric voltage is induced during the flow of a conductive liquid through the flow meter magnetic field. This is picked up by two electrodes in direct contact with the measured medium and evaluated in the electronic unit.

The FLOW 38 Batch type of induction meters are suitable exclusively for measurement of volumetric flow of electrically conductive liquid substances with a minimum conductivity of 20 $\mu\text{S}/\text{cm}$ (at a lower conductivity, upon agreement with the manufacturer).

Meters are designed for flow measurement where the velocity of liquid is in the range of 0.01 ÷ 12 m/s. The best measurement accuracy can be obtained in the range of 1 ÷ 10 m/s.

Scope of delivery

Accessories vary according to the variant of flow sensor and above standard optional features.

Threaded design

Electronic evaluation unit with a fixing bracket for wall mounting (not for the compact design), flow sensor (in case of compact design, the electronic unit is integral part of the flow sensor), connecting grounding cable, installation manual.

Sandwich design

Electronic evaluation unit with fixing adapter for wall mounting (not for the compact design), flow sensor (in case of compact design, the electronic unit is integral part of flow sensor), bolts for installation of the sensor between flanges (quantity as per tightening torque table, see below) with nuts and washers, connecting grounding cable, installation manual.

Flanged design

Electronic evaluation unit with fixing adapter for wall mounting (not for the compact design), flow sensor (in case of compact design, the electronic unit is integral part of flow sensor), connecting grounding cable, installation manual.

Food industry design

Electronic evaluation unit with a fixing bracket for wall mounting (not for the compact design), flow sensor (in case of compact design, the electronic unit is integral part of the flow sensor), adapter piping connection according to DIN 11851, installation manual.

In case of detached design, a special cable for connection of the meter (it must not be extended or cut short) is part of the flow sensor.

Storage conditions

The temperature during transportation and storage of the meter must be within the range of -10 °C to 50 °C.

Wooden boards installed on the flanges in the factory are used for protection of lining on the flanges during storage and transportation (for PTFE lining). Remove these protective boards just before installing in the pipeline!!!

Do not lift the flanged meters by the transducer head or by the connecting box of the detached design during transportation! Use slings and place them round both process connections for transportation of meters up to DN125 (chains may damage the meter head)! Use only the metallic lugs on the flange for transportation, lifting and installation of the sensor in piping in case of DN150 and bigger!!!

Warranty

Unprofessional installation or using the induction meters (devices) may result in a loss of warranty as well as failure to comply with installation or operating conditions according to this manual.

In case of returning the meters for inspection or repair to the COMAC CAL s.r.o. factory, enclose please the completed form, see the last page of this manual. Without having one, we will not be able to handle your requirement for modification or possibly repair your meter correctly and promptly.

Installation in pipeline

Important information for selection of location

!!! In case of detached design, the cable must not be extended or cut short !!!

Outdoor conditions

It is necessary to ensure that the flow sensor is not exposed to weather effects and that the measured medium cannot freeze in the flow sensor as it would damage the measuring tube.

In case of outdoor location of the electronic evaluation unit, the manufacturer recommends using a protective box or a roof to avoid direct solar exposure so that the evaluation electronics cannot get overheated.

Sources of disturbances

The following items rank among the most frequent sources of disturbances to the steady flow of liquid:

- Abrupt changes in pipe cross-section if not performed as a cone with an angle of $\alpha \leq 7^\circ$ (where α is the angle made by bevelled walls of the pipe reduction).
- Incorrectly centred sealing, low ID sealing or sealing made of soft elastic materials which are pushed out into the interior pipe cross-section after flanges are tightened.
- Anything interfering in the flow of liquid, for example thermowells, branch pipes, T-pieces, bends, elbows, slide valves, cocks, flap valves, shut-off valves, control valves, butterfly valves and check valves. Pipe outlets from tanks, heat exchangers and filters.
- No intensive magnetic fields in the proximity of the induction flow sensor (detector) must be present.

No sources of disturbances affecting the steady flow must be present in the straight pipeline sections. They must be located in the piping after the flow sensor or at the farthest distance before it. Sources of disturbances may substantially reduce the measuring range and accuracy of the flow meters.

Vibration

We recommend supporting the connecting pipes on both sides of the meter for partial elimination of vibrations. Levels and range of vibrations must be under 2.2 in the frequency range of 20 ÷ 50 Hz according to IEC 068-2-34. If the pipeline is exposed to excessive vibrations (e.g. from pumps), using compact meters is not recommended.

Actual location

The flow sensor (detector) must not be at the top position of the pipe which may be airlocked, or in declining or even in horizontal pipelines with open ends in which air may penetrate. Impurities may accumulate during long-term measurement of very low flow rates $Q < 0.1$ m/sec. There must be a sufficient pressure in the place of flow sensor installation so that the expulsion of gas or vapour bubbles from the liquid is avoided. Little bubbles that always occur in liquids may accumulate at any of the electrodes and this may result in incorrect operation of the meter. Gas bubbles are expelled also at an abrupt pressure drop. Therefore, butterfly valves and similar elements should be located **after the flow sensor**. For the same reason, the flow sensor should not be placed at the suction side of the pump. To prevent the bubbles from accumulation at a low flow in the flow sensor, it is suitable, e.g. that the pipe is slightly ascending or that the flow sensor is located in the vertical section of the pipeline.

If the meter is populated with measuring electrodes only (2 or 3 electrodes located **beyond the upper profile** of the tube), it is necessary for proper function of the meter, to fill up the flow sensor with the fluid to be measured so that erroneous readout of quantity of liquid passing through the meter can be avoided when the pipe is empty. It is necessary to select the location of the meter in such a way that the flow sensor aeration can be avoided. In the case of an open system, the flow sensor is placed in the bottom position of the U-profile pipework, ensuring that the fluid will not flow out of the sensor.

In the case that the sensor is equipped with an empty pipe testing electrode (3rd or 4th electrode in the upper part of the measuring tube profile), there is no risk of erroneous readout of quantity of liquid passing through the meter due to aeration of measuring electrodes. This function must be activated in PARAMETERS (EMPTY TUBE TEST) menu. If it be to the contrary, the same conditions apply as if the testing electrode is not populated.

The function of empty tube detection in horizontal mounting position operates correctly only if the evaluation unit is oriented upwards (see Fig. below). Alternatively, it is not possible to ensure that the activation of empty tube detection in case of partly filled or empty pipes will take place.

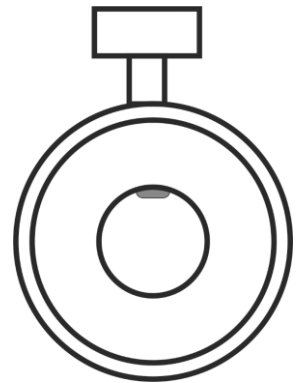

Due to the principle, it is necessary that the maximum conductivity of medium is 6000 μS for ensuring the functional evaluation of empty tube. Beyond this limit, errors may occur in empty tube test, and in this case, it is necessary to deactivate the empty tube test. If the conductivity of medium is beyond the permissible range, the meter may, despite the flooded system, register empty pipeline and the measurement will not start.

In case of any intervention into the measuring circuit must be accessed like a pipe is fulfilled of medium, and regardless of the displayed information "empty pipe test" on the display meter !!!

Installation examples

Trouble-free and exact operation of the meter is dependent on its correct location in the system. The most frequent methods of the placement are shown in the following figures:

Recommended installation locations

Downtake pipe

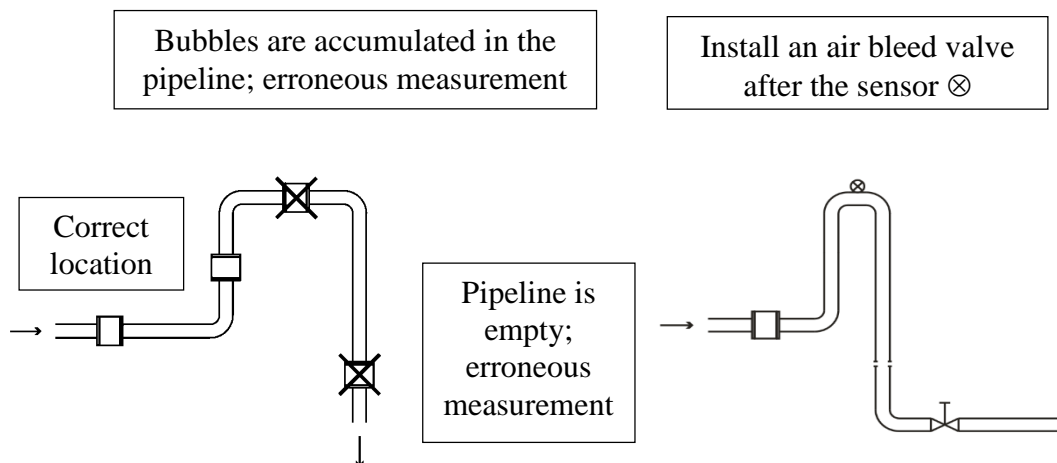

Horizontally laid pipeline

Place the sensor in a slightly ascending pipeline



Long pipeline

Install controls and shut-off valves always after the sensor

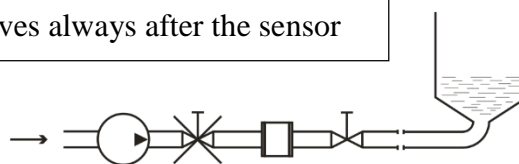

Free inlet or outlet

Built in the U-shaped pipeline

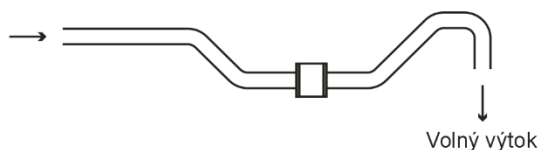

Pumps

The flow meter must not be installed in the suction side of the pump

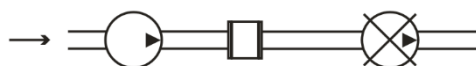

The flow of liquid flow in the flow sensor should be **steady and free of whirling**. For this reason, straight sections of pipeline with the same ID as that of the flow meter before and after the flow sensor (with permissible deviation of +5%). Recommended minimum length of straight sections is $5 \times d$ before the flow sensor and $3 \times d$ after the flow sensor where d is the inside diameter of the meter in millimetres. The same principles apply before and after the flow sensor in case of bi-directional flow measurement.

Recommendations

- In case of whirled up flow, extend the calming sections of pipeline or integrate a flow conditioner.
- When blending a mixture of substances, it is necessary to install the flow meter either before the point of blending or at a sufficient distance after it ($30 \times d$ min. where d is the inside diameter of the meter in millimetres), otherwise it will result in instability of indication.
- When plastic pipeline is used or in case of metallic pipes with internal non-conductive layer, earthing rings are needed.
- Do not install the sensor at the suction side of the pumps; this will eliminate the risk of vacuum and possible damage to the measuring tube lining.
- Pumps, bends and elbows found closely in succession in various levels should be at a distance of $20 \times d$ at least before the flow sensor. In case of a separate elbow or bend, the placement $10 \times d$ before the meter is recommended.
- When piston pumps, diaphragm pumps, and flexible tube pumps are used, it is necessary to install a pulse damper in the system.
- In order to provide the highest accuracy, it is important to ensure permanent flooding for the sensor (for example, by installation of the sensor in the U-shaped pipeline) even if the sensor is equipped with empty tube test. This will serve as an additional safety measure for detection of non-flooded tube.

The responsibility for suitability and adequacy of application of induction flow meters is borne by the designer or possibly the user himself.

Actual installation in pipeline

When welding both counter-flanges to the pipelines, it is necessary to maintain their **alignment** so that levelness of bearing surfaces of the flanges onto the front faces of the detector is ensured (at the same time, this must not be achieved by unequal tightening of the bolts as there is a risk of leakage due to thermal loading in the future or the measuring tube may break during such tightening). The difference of L_{MAX} and L_{MIN} distances of the sealing surfaces of the flanges before the flow sensor is installed **must not be greater than 0.5 mm**.

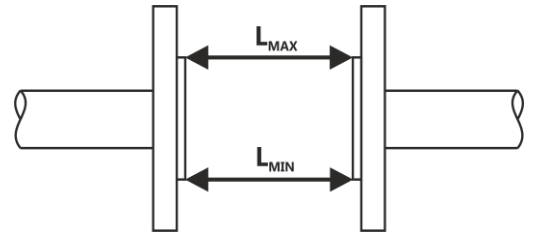

The opposition of the holes in the counter-flanges for the bolts should be ensured in the same manner and a sufficient room behind the flanges should be available for the bolts and nuts so that the actual installation of the sensor in pipeline and its attachment with the bolts is made possible.

The manufacturer recommends using an intermediate piece during welding. It is absolutely excluded to use the flow sensor as an intermediate piece due to thermal damage. The welding current must not run through the flow sensor during electrical welding. The installation of the flow sensor is carried out after welding, coating, building and similar works are completed.

The actual installation is performed by the fixation between the counter-flanges that are welded to the calming pipeline ($5 \times d$ before and $3 \times d$ in the direction of flow) whereas the liquid must run through the flow sensor in the direction **indicated by the arrow** on the sensor name plate.

During installation, do not lift the meter by the evaluation unit housing (in case of detached design, by the sensor terminal box), possibly under the meter's metallic housing but always use slings round the process connection or use the lifting lugs on the flanges.

Installation position

The inductive flow sensor is installed in arbitrary position in vertical piping. In case of horizontal piping, it is necessary to make sure that the sensor is installed with its measuring electrodes in horizontal position. In case of the earthing electrode design, possibly with testing for empty pipeline, then the installation is always performed with the earthing reference electrode facing down (with the sensor terminal box, eventually with the evaluation unit facing upwards). Then the earthing reference electrode is in the bottom position and the empty tube sensing electrode is in the top position of the flow sensor.

Every time when the empty tube testing electrode is not covered with a liquid for 5sec at least, the flow meter will display the "Empty tube" status, and if it is necessary, it sends out an error message and stops taking measurement. The measurement accuracy is maintained in this way. Once the electrode is covered with the liquid again, the error message disappears and the flow meter starts taking measurement again.

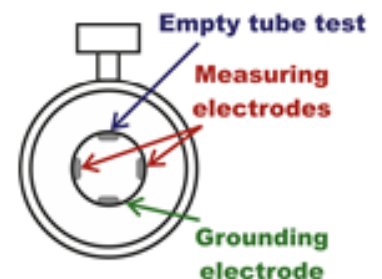

Installation in piping and placement of measuring electrodes in flow sensor

1) *in the version without the earthed reference electrode and/or empty piping test (2 electrodes)*

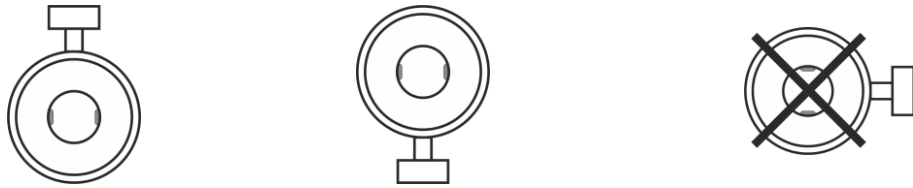

2) *in the version with earthed electrode and/or empty piping test electrode (3/4 of the electrode)*

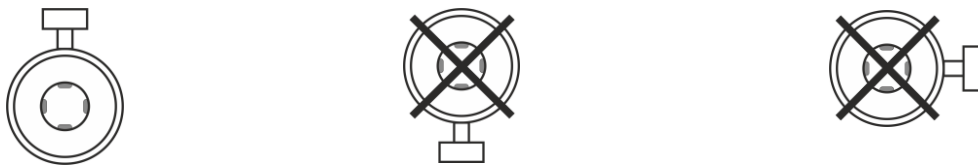

During installation, beware of:

- dropping the meter onto the ground and damaging the measuring tube or electronics
- contamination of the electrodes (do not touch the electrodes, otherwise they get contaminated)
- when additional sealing is used, avoid its interference in the flow profile of the detector between the flanges and the pipeline, otherwise the flow measurement error may be increased

Tightening torques

It is absolutely necessary to tighten the bolts and nuts equally by alternating sides and in the order shown in figure applying the maximum torque according to the table.

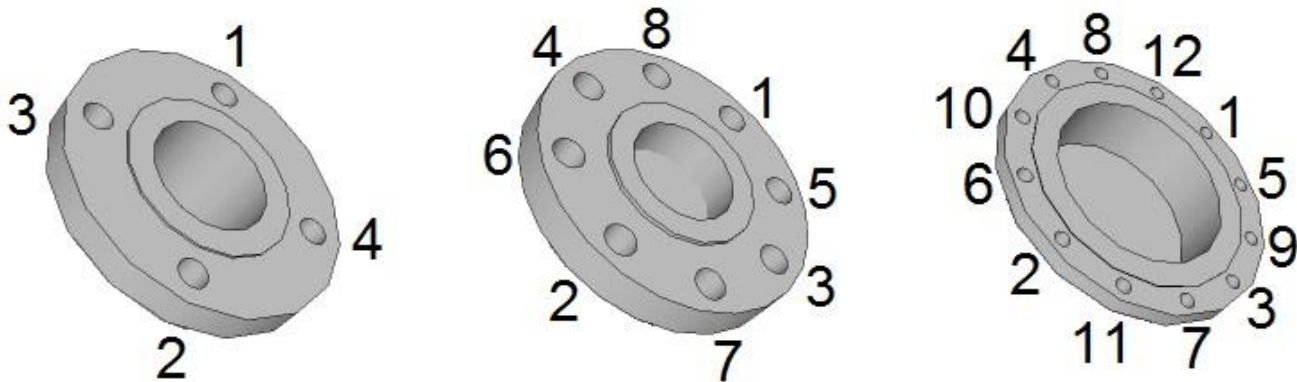

If the bolts are tightened too much during the installation of pipework components, deformation of the sealing surface may occur. In consequence, the torque values indicated in the table are used as a guidance for tightening the screws and bolts.

Table with tightening torques for screws/bolts:

Diameter nominal DN	PN 10			PN 16		
	Screws	Tightening torque [Nm]		Screws	Tightening torque [Nm]	
		Rubber	PTFE		Rubber	PTFE
15		20	25		20	25
20	4 x M12	20	25	4 x M12	20	25
25		20	25		20	25
32		20	25		20	35
40	4 x M16	20	25	4 x M16	20	35
50		20	45		20	45
65		20	46		20	46
80		20	48		20	48
100	8 x M16	20	50	8 x M16	20	50
125		20	80		20	80
150	8 x M20	24	90	8 x M20	27	90
200		25	115	12 x M20	28	80
250	12 x M20	27	95	12 x M24	38	110
300		34	115		55	150
350	16 x M20	47	140	16 x M24	75	160
400	16 x M24	65	155	16 x M27	85	200

Diameter nominal DN	PN 25			PN 40		
	Screws	Tightening torque [Nm]		Screws	Tightening torque [Nm]	
		Rubber	PTFE		Rubber	PTFE
15		25	25		25	25
20	4 x M12	25	25	4 x M12	25	25
25		25	25		25	25
32		25	35		25	40
40	4 x M16	25	35	4 x M16	35	50
50		35	45		35	60
65	8 x M16	35	46	8 x M16	45	55
80		40	48		45	60
100	8 x M20	40	55	8 x M20	50	75
125	8 x M24	50	110	8 x M24	70	120
150		57	115		75	136
200	12 x M24	68	100	12 x M27	85	145
250	12 x M27	88	120	12 x M30	105	-
300	16 x M27	95	125	16 x M30	115	-
350	16 x M30	115	200	16 x M33	140	-
400	16 x M33	135	255	16 x M36	165	-

The flanged connection design corresponds to EN 1092-1.

In case of using a corundum or thermoplastic tube, the same torques apply as in case of using the PTFE tube according to the given pressure series.

If you do not find your size or structure in the Torque Table, it is a special or non-standard design. In such a case, contact the manufacturer for more detailed information.

It is necessary to do the tightening three times, whereas for the first time, to 50% of the maximum torque according to the above given Table. For the second time, to 80% and for the third time, to 100% of the maximum torque. We recommend checking the screws/bolts for tightening some 24 hours after installation of the meter.

When installing the flow sensors over 200 mm, it is necessary to follow, except for the above mentioned rules, also simultaneous tightening of parallel screws on both opposite flanges to avoid possible damaging the electrodes or the measuring tube (symmetrical tensioning of the lining).

If the flanged joint is not tight, although all of the screws are tightened closely, **these must not be tightened more** but slackened on the opposite side to the untightness and tightened on the other side. If the untightness manifests itself even after that, it is necessary to check the sealing surfaces for scratches or mechanical impurities. If the scratches or any other damage are deeper than some 15% of the thickness of the flange, it is possible to remove them using fine emery paper.

In case of the threaded connection, it is necessary to check, while tightening, the screwed connection on the sensor so that torsional displacement is avoided.

Seal

The turned up part of the lining does not carry out the function of sealing so it is necessary to insert the appropriate seal precisely centred between the sensor and the pipeline. If the sealing extends in some place into the flow profile, it makes whirls and reduces the measurement quality. Use the seals compatible with the liquid and 5mm thick. Do not use graphite or any other electrically conductive material to hold the sealing in place during installation. It could influence the measuring signal accuracy.

Earthing

For reliable and correct operation of the induction sensor it is necessary to provide proper protective and working earthing. The earth line must not transmit interference voltages so the other electrical devices must not be earthed by means of this line.

The flow sensor is provided with the M5 earthing screw of stainless steel with a washer and nut for proper connection of the sensor body with both counter-flanges of the metallic pipeline. The earthing cable lug is screwed there and it should be conductively connected with the counter-flanges. On the counter-flanges, it is recommended their connection to the welded crews or into a threaded hole. Connecting under the fixing screws of the flange is not suitable as they may corrode with time and cause failures in measurement.

However, if it is not ensured that the counter-flanges are in direct contact with the measured media and they are conductive, the earthing rings must be used, refer hereinafter.

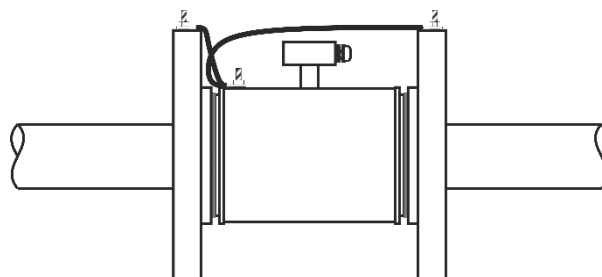

Earthing rings

Using for a plastic pipeline or in case of metallic pipelines with internal plastic lining turned up or pulled out to the front faces of the pipeline flanges. Conductive earthing rings of stainless steel create conductive connection with the measured substance. Usually, potential equalization is carried out by means of the reference earthing electrode in the measuring tube. In exceptional cases, the equalizing currents may run through the reference electrode based on the device earthing conception. This may lead to deterioration of the sensor, e.g. by electrochemical disintegration of the electrodes. In such cases, it is **necessary** to use the earthing rings for potential equalization. This holds true for two-phase or two-component flows in which the medium is blended badly or its components cannot be blended. In general it can be said that using the earthing rings is always the protection against stray currents and the warranty of correct measurement at the same time.

The flow sensor is provided with the earthing screw of stainless steel for the earthing cable supplied with the mounting accessories. Then this cable must be conductively connected with the earthing rings.

The earthing rings are not part of our standard package and must be ordered separately. Chemical durability of the material must correspond with the liquid to be measured; it is usually made of the same material as the sensor electrodes. While mounting, it is necessary to insert seals in both sides of the earthing ring and take care that no part extends to the internal profile of the sensor (whirling and turbulence of the medium).

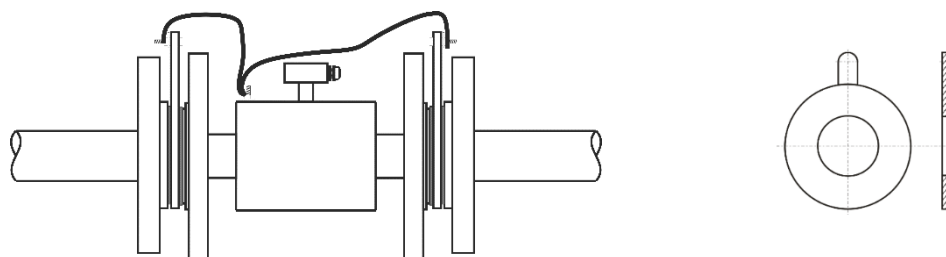

Electrodes

The electrode material must be selected according to chemical resistance to the liquid to be measured. The purity of the electrodes may have an influence on measurement accuracy, their heavy foulness may cause even the interruption of the measuring function (isolation from the liquid). It is not necessary to clean the electrodes right after delivery before their installation in the pipeline. If the electrodes indicate signs of foulness, clean them with a soft cloth or use a chemical cleaning agent. Mind damaging to the lining! During routine operation, in case of a great majority of liquids, it is not necessary to clean the flow meter for the entire operation period of the flow sensor; self-cleaning by flow of the liquid is sufficient (recommended velocity is over 2 m/sec).

PTFE lining

Meters with PTFE lining are equipped with protective covers to prevent the sealing surfaces from damaging during transportation or storage and from changing the shape (due to elastic memory of the PTFE material, it is restraightened to the tube). Protective covers may be removed only right before the installation. If these covers are removed due to a check, it is necessary to replace them immediately.

Carry out the installation at the lowest point of the pipeline to avoid the occurrence of vacuum. Never detach and damage the rim of the PTFE lining turned up to the of flow sensor faces. Remove the covers from the inlet and outlet sides right before insertion of the sensor between the pipeline flanges and replace them with metal plates (0.3 ÷ 0.6 mm thick). After insertion of the sensor, remove the metal plates and install the screws/bolts.

High temperature pipeline and High temperature medium

At temperatures of the medium to be measured over 100°C, it is necessary to compensate the forces caused by thermal expansion of the pipeline due to its temperature rise. For short pipelines, it is necessary to use flexible seals, for long pipelines, use flexible pipe elements (e.g. bends).

The flow sensor must never be thermally insulated. In case that the sensor is placed in a thermally insulated pipeline, the thermal insulation must be interrupted and the flow sensor is installed without thermal insulation.

When a compact meter is used (evaluation unit placed on the sensor body), it is necessary to respect the temperature of medium up to 90 °C. In case of exceeding this temperature, the correct functionality of the electronic evaluation unit is not guaranteed, or there is a risk of its destruction.

Installation check

After installation of the flow sensor in the pipeline, the following must be checked:

- According to the name plate, if there is a relevant meter in the given measuring point (pressure, temperature, dimension, etc.).
- If the direction of the arrow on the device is in agreement with the direction of the flow in the pipeline.
- Correct position of the measuring electrodes (horizontally).
- Correct position of the electrode for empty pipeline detection (up).
- If all bolts (screws) are tightened properly.
- If earthing rings are used, then their correct installation and connection with the sensor.
- Accuracy of flow sensor earthing.
- Accuracy of execution of the pipeline calming section lengths
- If the sensor is protected against vibrations and mechanical damage.
- If the name plate (serial number) on the sensor corresponds to the one on the electronics.

Wiring

*Workers performing wiring are subject to the requirements of Decree No. 50/1978 Coll. on activities on electrical equipment!!! When the operations described below are performed unprofessionally, the claim on warranty becomes extinct!!! Prior to any opening of the evaluation unit, switch off the power!!! It is necessary to bear in mind that in case of detached design, the electronic evaluation unit and the flow sensor form an integral unit which is calibrated and matched uniquely. In consequence, make sure that **the serial numbers of both parts are always identical!!!***

Important information

Flow sensor connecting cable

The signal cable of the detached induction flow sensor cannot be led in parallel (even partly) with the cables for power distribution voltage or in the proximity to electric motors, electromagnets, contactors, frequency converters and similar sources of electromagnetic interference. In unavoidable situations, it is necessary to put the cable in an earthed iron tube. Primarily in media with a low conductivity, cable movements and interference may result in distortion of the measured signal. The maximum length of the cable between the sensor and the evaluation unit is 30 metres provided that the conductivity is over 50 μ S/cm. In case of lower conductivities, it is recommended to use the shortest possible cable length, however, 10m max.

In case of detached designs, it is possible to interconnect only the sensor and the transducer with the same serial numbers. The special cable for connection of the detached meter design must not be extended or cut short. In case of infringement of these requirements, measurement failures and significant inaccuracies may occur once the meters are connected.

If it is possible to expect an increased level of unwanted electromagnetic field, we do not recommend using the detached design. In places with strong electromagnetic interference (in the proximity of frequency converters, electric motors, transformers, etc.), we recommend putting a line filter before the meter in the power supply circuit.

Evaluation unit

As standard, the evaluation unit is delivered for mains power supply 230V / 50 \div 60Hz. It is possible to specify also DC power (as standard, 24V AC/DC / 250mA).

For securing the tightness of the evaluation unit cover, it is necessary to keep the seal intact and clean (replace the damaged seal immediately). If the holes for cable entries are not occupied, it is necessary to do it.

The flow meter signal outputs may only be connected to devices where accident protection is provided by a safe low voltage and where generated voltages do not exceed the limits defined for safe low voltage.

In case of mains power 230V / 50 \div 60Hz, the meter is fed by a switched power supply which may contain beats in acoustic spectre whereas this symptom does not indicate a failure of the meter.

Never make kinks on the cable and on individual conductors and do not let them cross mutually in the terminal board area and always use a separate cable grommet for power supply. Cover the unoccupied grommets with a piece of cable or a plastic plug (securing of tightness).

Installation of the meter's detached evaluation unit

Wall mounting:

For mounting on the wall are at the device indicated four mounting points forming a rectangle with dimension 106x186mm (total box height is 200 mm). These points then drill and place with the dowels, screws, install the unit to the wall and do the wiring. After completion, close the unit and tighten all screws.

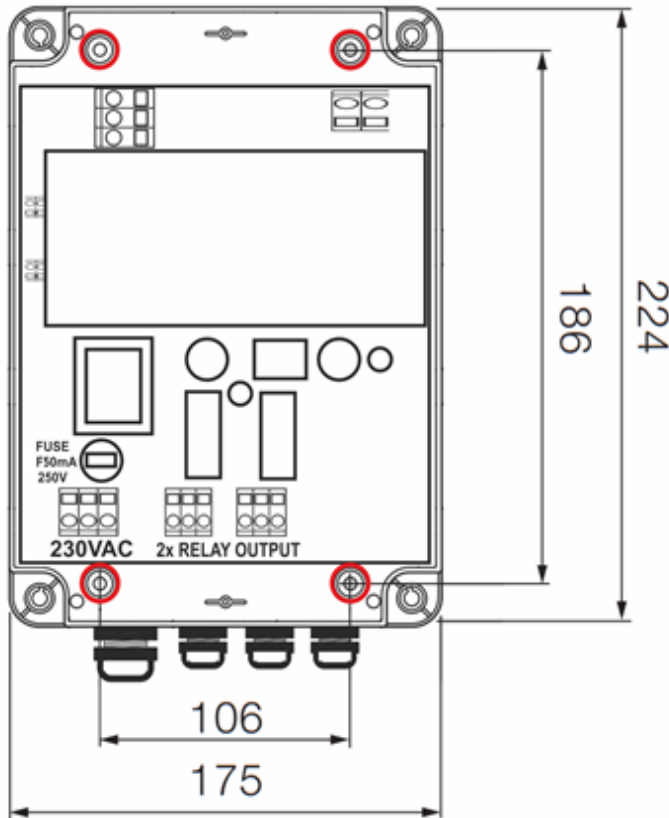

Total depth of box is 200mm!!!

Meter wiring of batching unit

The actual wiring is done by bringing electrical power supply wires 230VAC and controlling wire for the valve of one of two relay outputs (it is double output in case of damage to the first relay, or when there is a need to control two devices). Once the wiring is done, close the box and by fastening of the corner screws secure the cover against opening. Next use the connectors to connect the flow sensor cable. Fix the cable to the wall or structure so that it does not "hang" off the connector. Below the connector create a "drip loop" facing down so that any dripping water would not wet the connector. Similarly, fasten the wires for supply voltage and control outputs. At this stage the device is ready to operate. The internal control board is already connected with a measuring device – this has been done inside the COMAC CAL factory. If this is not desirable, do not interfere with the wiring.

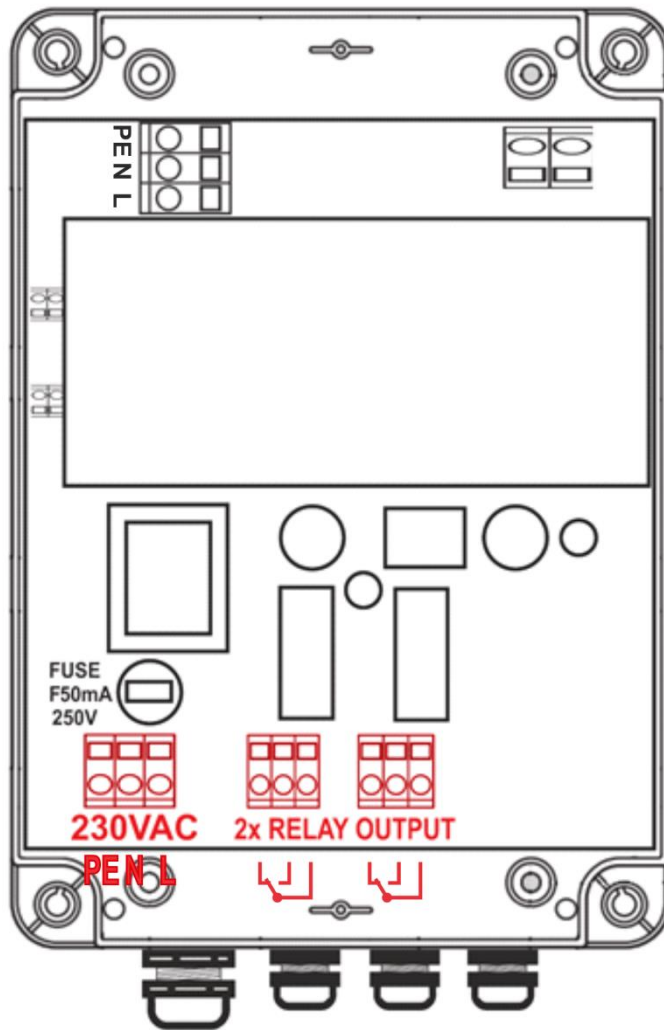

**Meter wiring of sensor
(Standardly made in COMAC CAL factory)**

Evaluating unit is consists of two units:

Front panel with display unit

Back panel with outputs, inputs and power

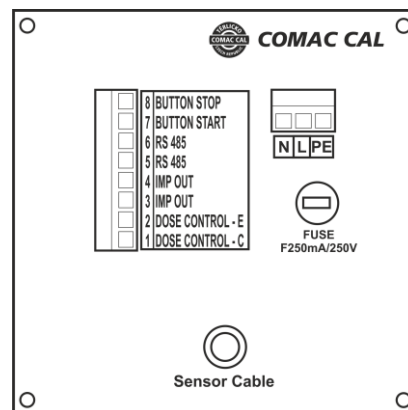
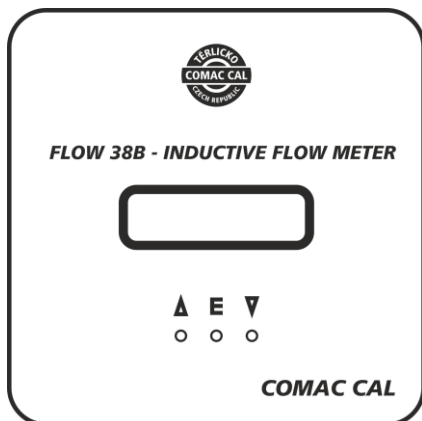

Terminal connection of the evaluation unit:

- Terminal 1 – controlling of batching valve C
- Terminal 2 – controlling of batching valve E
- Terminals 3 and 4 – puls output OUT IMP
- Terminals 5 and 6 – communication RS485
- Terminal 7 – button START
- Terminal 8 – button STOP
- Terminals L,N,PE – supply voltage 230 VAC

These terminals are in the batching device already connected to the control supply plate.
Terminal connection and jumpers is always described on the cover sheet of power supply and back cover.

Impuls output / Flowswitch contact

The output of volumetric impulses (switching contact) is implemented by an NPN transistor. Limit parameters of this optocoupler are 80V/50mA/100mW max.

The volumetric impulse output is used for remote transmission of volumetric impulses. The conversion constant is arbitrarily variable using buttons or user software. The adjustment must be carried in such a manner that $f_{out} < 400\text{Hz}$.

The impulse output (switching contact) may be active or passive.

In active mode, the meter takes advantage of internal galvanically isolated 16V power supply. The voltage at the output is in the state of 16V pulse, the recommended drawn current is 2.5mA. At the moment beyond the pulse, the output is at the state of high impedance (if the input of the device does not contain an internal pulldown resistor, it is necessary to provide it)

Wiring connection examples – *passive impulse output:*

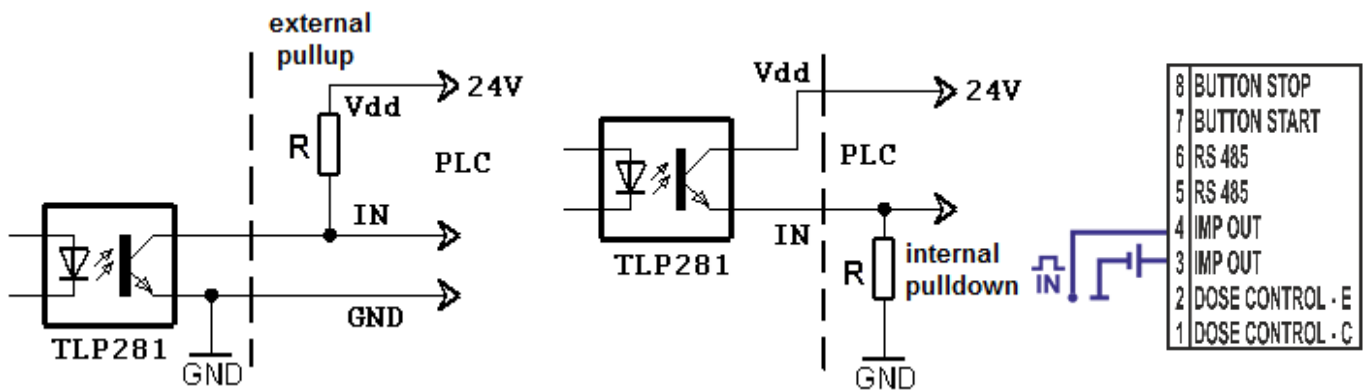

Due to $CR \approx 100\%$ and $I_f = 2.5\text{ mA}$ it is advisable to choose the collector current up to 2.5 mA.

Buttons START, STOP

Applying a signal to the GND terminal 7 or 8 you can start or stop the batch. These terminals are in batching devices already connected to the control buttons.

Controlling of the batching valve

Terminals 1 and 2 are used to control the relay valve batching device. These terminals are in batching devices already connected to the control board with relay outputs.

Data output

The Flow 38 Batch meter can be provided with RS485 communication interface with M-Bus protocol according to EN 1434-3 or ModBus RTU.

Protection degree

The meters meet all the requirements for IP 65 protection degree.

Replacement of tube fuse in the meter

!!! Risk of electric shock! Uncovered components generate dangerous voltages. Before removing the cover from the electronics area, make sure that the meter is not under voltage!!!

The instrument fuse is on the power supply PCB and it is replaced as follows:

1. Switch off power.
2. Unlock the corner screws and remove the cover instrument boxes
3. Remove the protective cover and replace the instrument fuse (use solely F50mA/250V tube fuses for power source part and F250mA/250V for measuring part)
4. Proceed in reverse order to recover the function of the meter.

power source part

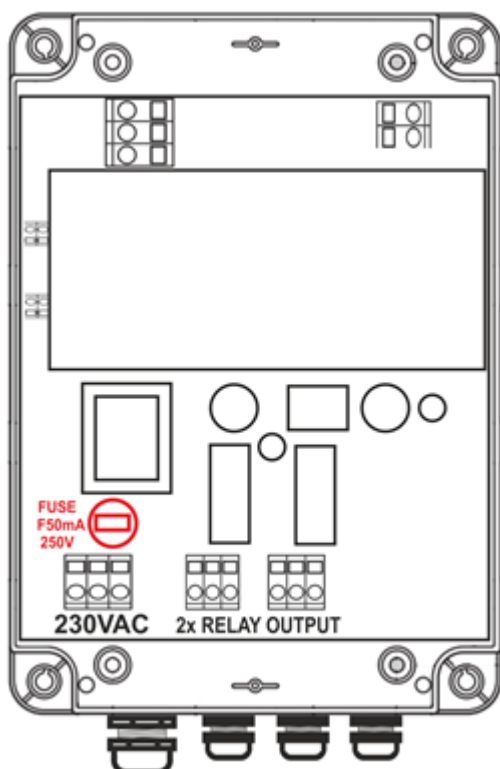

measuring part

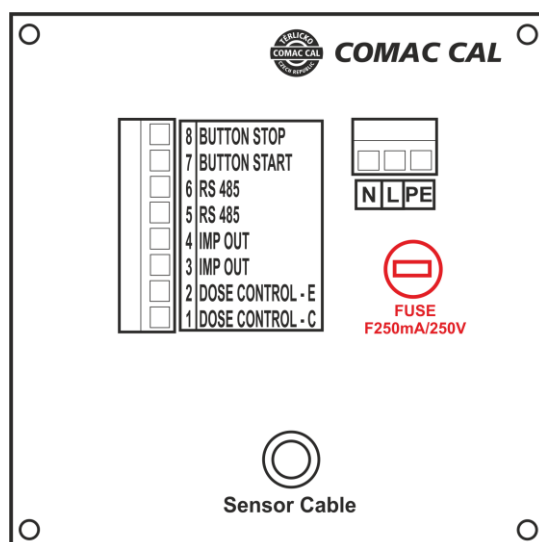

Wiring check

After completion of wiring, it is necessary to check:

- Connecting cables for damage.
- If the cables used are suitable for given cable entries.
- Cables for pull relief.
- Correct tightening of cable entries.
- Correct connection of cables to terminals.
- Whether the supply voltage corresponds with the nameplate data.
- After closing the device properly tightening the lid.

Putting into operation

Prior to connection to power supply, check the device installation accuracy in accordance with “Installation in pipeline“ and “Wiring” chapters.

If you wish the meter to take measurement as precisely as possible right after powering up, it is a good idea to fill the flow sensor with water, one or two days before its installation, so that all of its electrodes are flooded. Just before the installation, the water is discharged and the sensor is installed into piping. Right after installation, piping is filled with a medium so that the electrodes cannot dry off.

If the meter has no electrode for empty tube detection, do not connect the meter to power before filling the system with the fluid to be measured and power off the meter before system discharge.

Once the meter is powered up, the green LED on the front glazed panel is lit, confirming the supply voltage on the control PCB and stabilization of parameters of the meter takes place subsequently. The stabilization is indicated on the meter's display. After that period of time, the meter starts measuring.

Meter status:

It is displayed continuously on the screen as one of the main menu items and in case of a non-standard state or a failure, this is displayed by alternating indication of the status and main menu basic data and the operator is warned by a text. The meter status is divided into 4 basic groups:

- | | |
|---------------|---|
| 1) OK | everything is all right |
| 2) Warning | the meter takes measurement but some of the parameters are out of range |
| 3) Error | critical error – the meter does not take measurement |
| 4) Empty tube | if the EMPTY TUBE TEST function is activated |

Flow direction:

The arrow indicates the direction liquid flow inside the sensor and thus the correct orientation of the meter's sensor for installation in piping. In case of inversely performed installation, it is possible to toggle the direction in electronics between positive/negative and thus avoid incorrect value imaging and reading out .

Basic parameter settings

The meter or flow meter parameters are set by the manufacturer in accordance with the purchase order. If these values are not indicated in your purchase order, the meter will be set up using the default

parameters in accordance with the meter's range. The operator can make modifications by means of three buttons on the meter's panel or through the RS485 interface.

Safety rules for operator

Any interventions in the inductive flow sensor and evaluation unit itself are illegal on the part of operator and they may lead to direct scalding by medium. Perform electrical connection always after powering off.

FLOW 38 BATCH OPERATING INSTRUCTIONS

The meter is provided with two external buttons on the side of the electronics housing and with three internal buttons on the bottom of the measuring electronics PCB which is accessible after unscrewing the front glazed cover.

Functions of control (lower) buttons:

- | | |
|----------------------|--|
| Potenciometer | Setting the batch size, the minimum setting value of the potentiometer corresponds to the limit for the minimal batch and maximum value of the potentiometer then the maximal batch (see p. 26). |
| Green "START" button | Start the set dose from the beginning, or its restart, if the previous stop red button. |
| Red "STOP" button | Stop ongoing dose. In the case the batch is stopped yet, than this unfinished dose is cancelled and the unit is ready to be restarted dose again from the beginning of the green button. |

Function of setting buttons (under display)

Before pressing **E** and entering the password

- | | | |
|--------------|--|---|
| ▲ | short press | movement in current menu up or modification of the value at the cursor up |
| ▼ | short press | movement in current menu down or modification of the value at the cursor down |
| ▲ / E | long press (>3sec) | entry to PARAMETERS menu |
| ▼ | long press (>3sec) | exit from PARAMETERS menu |
| ◆ | simultaneously ▲ and ▼
(short press approx. 0.5sec) | resetting user rV counter in PARAMETERS menu while entering values by an order back |
| ◆ | simultaneously ▲ and ▼

(long press >3sec) | in PARAMETERS menu, end of modification of values without writing |
| ◆ | simultaneously ▲ and ▼
(long press >8sec) | total restart of the meter |
| E | short press | confirmation (Enter) or modification of a value (setting) |



Basic display menu contains the following items:

Date and Time	D/T
Current flow	Q
Dose setting	Vrun/stop
Volume in positive direction against the arrow on the meter's name plate	+ V
Volume in negative direction against the arrow on the meter's name plate	- V
Total volume (summary in both directions)	ΣV
Dose volume (in positive direction only)	r V
Status	OK

The order may vary as per meter's settings. The customers may select the data to be displayed on the first two lines (or change the order) in such a manner that corresponds to their requirements.

In case that the meter's status is found in a different than normal and correct (OK) status, measurement failure indication alternates with the normal display indication. As a consequence, it is not necessary to check the status all the time; in case of trouble, it is indicated on the display unit automatically.

Using both external and internal \blacktriangle and \blacktriangledown buttons, you can list in basic menu, reset the user volumetric counter (by simultaneous pressing both buttons), enter PARAMETERS menu, list in it and exit from it.

PARAMETERS menu contains the following menu items:

1. DATE AND TIME
2. OPERATION TIME COUNTER
3. POWER LOSS COUNTER
4. IMPULSE OUTPUT or FLOW SWITCH
5. SETTING OF THE RANGE OF DOSE
6. COMMUNICATION
7. BASIC INDICATIONS ON DISPLAY
8. DISPLAY DIMMING
9. DISPLAY BACKLIGHT
10. SERIAL NUMBER
11. CALIBRATION CONSTANTS
12. EMPTY TUBE TEST
13. FIRMWARE VERSION
14. DEAD BAND – MEASUREMENT START SUPPRESSION*
15. ZERO CALIBRATION*
16. FLOW SIMULATION
17. LANGUAGE
18. COUNTER RESETTING*
19. NOMINAL DIAMETER (DN)
20. FLOW DIRECTION*
21. FLOW UNITS DISPLAYED [Q]
22. VOLUME UNITS DISPLAYED [V]*
23. PASSWORD CHANGE
24. DEFAULT SETTINGS (ORIGINAL FACTORY SETTINGS)

* *If the meter is delivered for billing purposes, then these parameters marked with an asterisk cannot be changed (in case of restoration of factory settings, the volumetric counter is not reset).*

For editing items in PARAMETERS menu, the central **E** button is used, once it is pressed down, the operator is asked for authorization of access by password (by default, it is **0000**). Consequently, it is possible to use the **▲** and **▼** buttons to change the value upwards or downwards and confirm the modification by the central **E** button. In case that the parameter to be changed is not a numerical one, the entire parameter is changed by means of a "scroll bar". The password is required only at the first entry and it will become invalid after returning to basic display or within two and a half minutes of inactivity when the meter returns again to its basic display automatically

Examples of representation in normal status according to user settings:

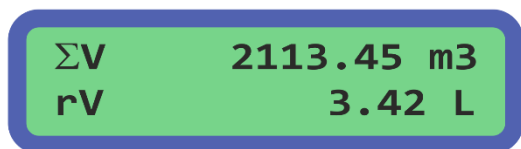
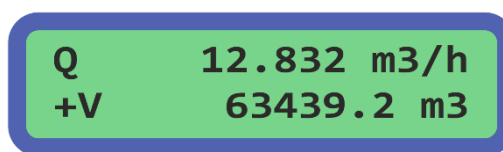
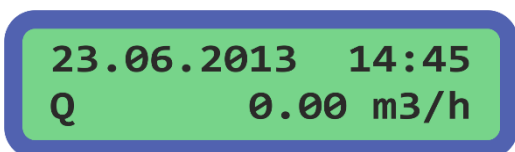

Note: The order of representation of menu items can be modified by user according to the customer's needs.

Procedure to set individual menu items:

Within framework of setting, it is necessary to unscrew the front cover with glass window to get access to internal buttons. After initial entry to Parameters menu (long press of **▲**) and an attempt to edit an item (by **E** button), the operator is asked for entering an authorization access code (by default **0000**). This is entered successively for each of four digits separately from left to right using the **▲** or **▼** buttons whereas the transfer of cursor to another digit, including the final confirmation of the entire code is implemented by the **E** button. By applying a double press **◆** (simultaneously **▲** and **▼** short press approx. 0.5sec) you can return by one position and correct it. In case of entering an invalid password, modification of parameters is not enabled and the password entry must be repeated.

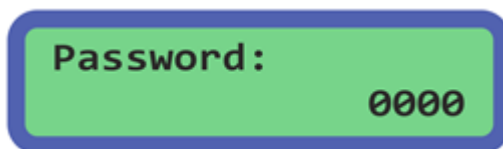

Note: The password will become invalid after returning to basic display or within two and a half minutes of inactivity when the meter returns again to its basic display automatically.

Entering numerical values for individual menu items takes place in a similar manner.

If it is not a freely adjustable numerical item but a list of possible values, the selection is implemented by successive scrolling using the **▲** or **▼** buttons and once the desired value is displayed, you simply confirm the selection by pressing the **E** button.

After successful entry, the confirmation of the request for modification is required by the **▲** or **▼** buttons, followed by selecting YES/NO and confirming by the **E** button. By doing this, the modification is saved in the internal memory of the meter.

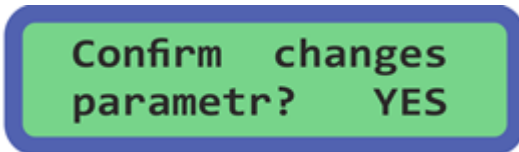

1) *DATE AND TIME*

This menu item is in DD/MM/RRRR HH/MM formats

Use the **▲** and **▼** buttons to set the menu item on the display and press the **E** to edit. Implement settings in a standard way, using the setting buttons and confirm by pressing the **E** button.

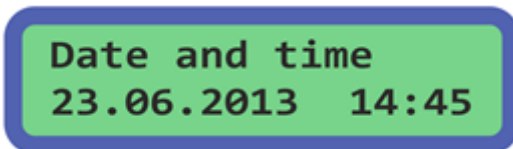

It is necessary again to confirm the change.

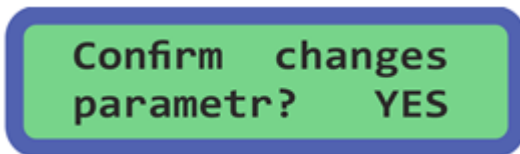

2) *OPERATION TIME COUNTER*

The counter registers the operation time of the meter (switching on). The first line indicates the date when the last counter reset was performed and the second line indicates the length of operation in days, hours and minutes.

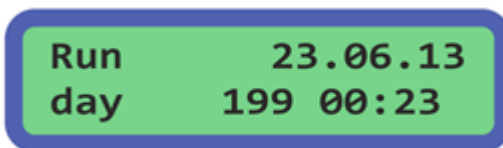

This counter can be reset by pressing the **E** button when necessary.

3) *POWER LOSS COUNTER*

The counter registers the time of loss of power time for the meter. The first line indicates the date when the last reset of power loss counter was performed and the second line indicates the length of time when the meter was out of operation in days, hours and minutes. The counter can be reset again by pressing the **E** button.

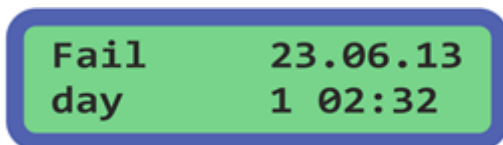

4) **IMPULSE OUTPUT / FLOW SWITCH**

This output can be configured as the impulse output or the Flow Switch contact.

Impulse output

For complete setting the parameters of impulse output, it is possible to change the logics (polarity) of the electrical signal (positive/negative), to set the impulse output to which the volumetric counter will respond (volume run in positive direction, in opposite direction and in both directions) as well as your own impulse constant, including its indication (imp/L or L/imp).

```
ImpOut      POS/+V
IMP         10 L/imp
```

The impulse width cannot be set freely using an arbitrary value but it is necessary to select a suitable impulse width from the predefined width menu (by scrolling the predefined values using the \blacktriangle or \blacktriangledown) buttons.

```
ImpOut      POS/+V
width : 7.6 ms
```

Flow switch

For complete setting the parameters of status output, it is possible to change the logics (polarity) of the electrical signal (positive/negative) and then set to which volume the output will respond (flow in positive direction, in opposite direction and in both directions) as well as your own switching point value.

```
FlowSw      POS/+Q
Qlimit      10 m3/h
```

The status contact makes it possible to set the amount of hysteresis between Qon and Qoff states.

```
FlowSw      POS/+Q
Hyst:       10.0%
```

5) **Setting of the range of dose**

For Setting dose range uses two parameters, which set the maximum and minimum of dose between the rotary element. Selecting of the maximum value automatically affects the resolution in which it is possible to adjust the dose so that was the setting value by rotary buttons stable - usually can figure set to 3 significant figures (999 position of rotary switch). It means for setted max. dose 1000 litres will be one step 10 litres changing by the rotary switch etc..

Setting then proceeds in a conventional way by changing the dose in m3 for the minimum, and consequently the maximum limit.

Set Dose [Min]
Vstop 0.002 m3

Set Dose [Max]
Vstop 0.200 m3

6) COMMUNICATION

If the meter is ordered with communication, it is possible to set all of its parameters. For selection of an address, any number 0 – 255 can be set and the velocity should be selected according to custom practice. If you wish to change the type of communication, press the **E** button. Then press \blacklozenge (simultaneously \blacktriangle and \blacktriangledown approx. >0.5sec). Select the desired communication type by \blacktriangle or \blacktriangledown and confirm the selection by the **E** button.

Once the MBus/MODBUS type of protocol is to be changed, the recommended velocity for these communication types is completed automatically.

Rs485: MODBUS
Adr: 157 9600Bd

Rs485: MBUS
Adr: 001 9600Bd

Rs485:
not available

If communication was not ordered.

7) IDLE STATE BASIC INDICATIONS ON DISPLAY

Basic indications in idle state can be influenced and modified in such a manner that the data needed by the user can be found on the first two lines on the display. Whereas the order of the other items is retained. If you want to change a setting, press the **E** and \blacktriangle or \blacktriangledown buttons and select the data on the line which is then confirmed by the **E** button. The customer can select from these indications, namely both on the first and the second lines:

- Date and Time
- Dose volume user defined volume rV
- Total volume $\sum V$ sum of volumes in both directions
- Volume (-) direction reverse flow volume -V
- Volume (+) direction volume in positive flow direction +V
- Dose setting
- Flow current flow Q

LCD line 1
Date and time

LCD line 2
Flow

8) *DISPLAY DIMMING*

The period of averaging flow values within the range is set here. Maximum value is 29sec. Averaging is then used for the other outputs as well.

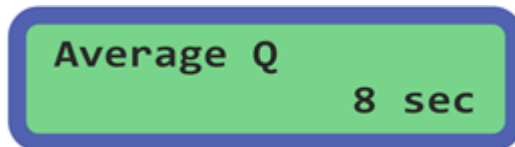

9) *DISPLAY BACKLIGHT*

Here, you can set the period during which the display backlight is turned off after the last activation of a button. Use the ▲ and ▼ buttons to select the desired settings from menu (permanent, 40sec, 20sec, 10sec, switched off).

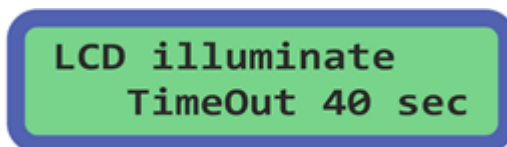

10) *SERIAL NUMBER*

The serial number is registered in the factory and cannot be changed by user.

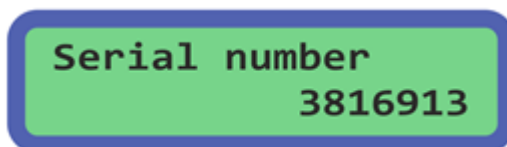

11) *CALIBRATION CONSTANTS*

Calibration constants are registered during the production and cannot be changed by user.

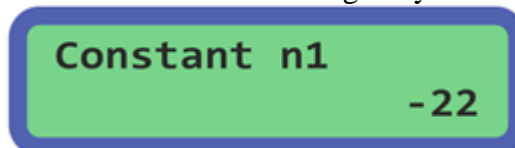
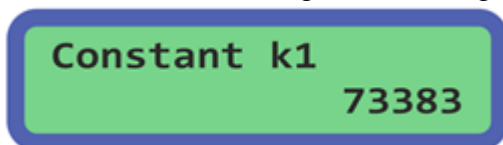

12) *EMPTY TUBE TEST*

Activates and deactivates monitoring of measuring tube filling. If the meter was ordered without the testing electrode, the flooding test cannot be activated. Two levels of the empty tube test activation are available for standard conductivity ON(1) and for increased conductivity ON(2).

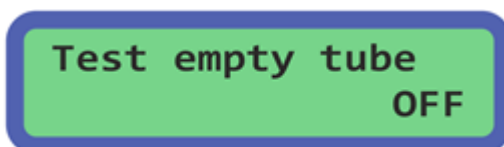

13) *FIRMWARE VERSION*

The firmware version is registered in the factory and cannot be changed by user.



14) *DEAD BAND – MEASUREMENT START SUPPRESSION*

If you want to change the flow value for the start of measurement, press the **E** button.

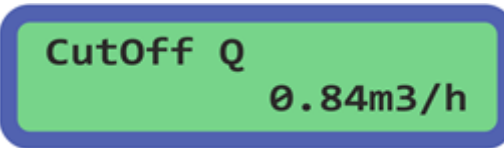

15) *ZERO CALIBRATION*

The date under "Zero calibration" heading indicates the date when zero flow calibration was performed.

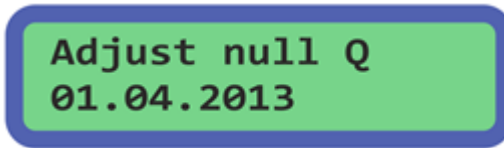

If you want to recalibrate the zero flow, press the **E** button. The flow meter evaluates the measured data automatically and if YES is set, upon confirmation of the selection by the E button, a new value for zero flow will be set and the date of the last recalibration is updated (when NO is selected, the value for recalibration is not registered and everything remains in original setting).

Note: Before recalibration is performed, do not forget to close the valves first and secure a real zero flow (stationary medium) in the system.

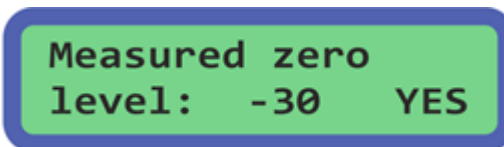

16) *FLOW SIMULATION*

Flow simulation serves for comfortable setting and checking the systems in which the flow meter is used without necessity to use realistic flow of medium through the meter and without necessary installation of the meter in the pipeline. The display shows the simulated flow and current and impulse outputs of the meter correspond to this data. Such a simulated flow is not registered in the volume registry, of course.

WARNING! If the meter runs in simulation flow mode, it does not return automatically after two and a half minutes as it is typical for all other modes and representations. After termination of flow simulation mode, it is necessary to exit Parameters menu by the (▼ long press >3sec) button!!!

The customer can set the value of the simulated flow. If you want to activate or deactivate the simulation, press the **E** button.

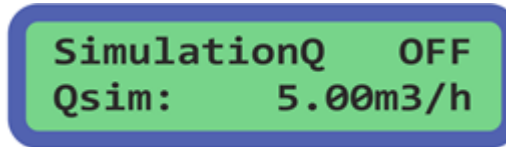

SimulationQ OFF
Qsim: 5.00m³/h

17) LANGUAGE

If you want to change the meter's language, press **E** and then select a desired language from menu.

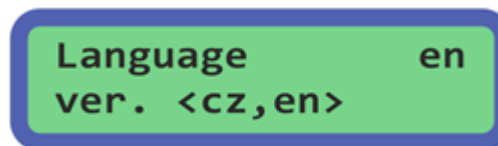

Language en
ver. <cz,en>

18) COUNTER RESETTING

Here, it is possible to reset all or only certain volumetric counters. If you want to perform resetting, press **E** and select which counter you wish to reset (ΣV , -V, +V or all). After resetting, the date when the last reset was performed is displayed and which counter was reset (again, ΣV , -V, +V or all).

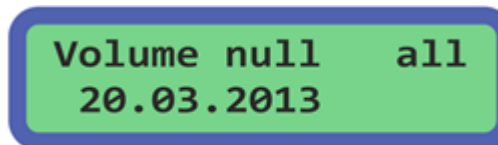

Volume null all
20.03.2013

19) NOMINAL DIAMETER (DN)

This parameter is set in the factory and cannot be changed.



Sensor DN50

20) FLOW DIRECTION

Specifies the direction of flow in the flow sensor with respect to the data in electronics. Positive direction is the flow in the sensor identical to the arrow indicated on the meter's name plate. If the medium flows through the sensor against the arrow on the sensor, select the NEGATIVE direction.

If you wish to make the change, press **E**.



Flow direction
positive

21) FLOW UNITS DISPLAYED [Q]

If you wish to change the way of flow indication, press **E** .

Use the **▲** and **▼** buttons to set the required number of decimal places and by confirming with **E**, go to setting the flow unit representation.

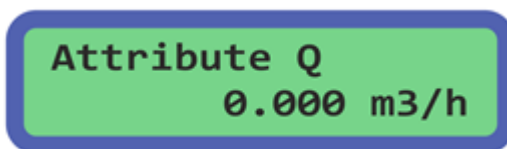

22) VOLUME UNITS DISPLAYED [V]

To change the way of volumetric indication (+V, -V and ΣV), press **E**. The number of decimal places for the volumetric counters can be selected from 3 to none. Furthermore, the selection of units is here (L, m³). If these parameters are changed, the respective measured value will be changed as well. In consequence, we recommend resetting of the counters changed in this way after reconfiguration.



23) PASSWORD CHANGE

The password for modification of the customer parameters is set by default to **0000**. However, the user can change it in this window by pressing **E**. The access code must have 4 digits.

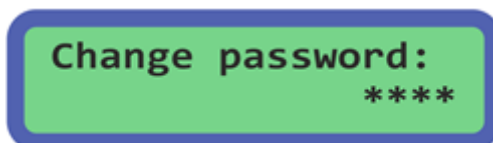

24) DEFAULT SETTINGS (ORIGINAL FACTORY SETTINGS)

During activation of this function, the configuration of the meter will be restored to the factory default state in which it was shipped. All user settings will be deleted and if the metrology jumper J1 on the power supply board is connected (non-certified meter used for **non-billing** purposes), all volumetric counters will be reset as well.

The user password is cancelled and the access code is reset to original (0000).

This applies to calibration of the meter as well. Before activating this function, it is useful to record or make a back up of the data of all counters.



This function can be activated without the access code!

If you wish to apply the original factory settings, press **E** and use the **▲** or **▼** button to select YES from menu and then confirm by **E**.

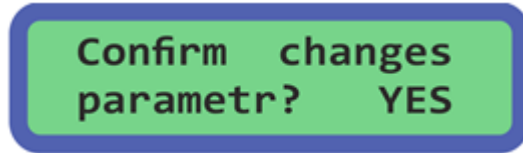

After confirmation of the change, the meter will have the settings it had when it was delivered by the manufacturer.

Technical data

Evaluation electronics technical parameters

Supply voltage:	230V AC (+10; -20%) 50 ÷ 60Hz	(standard)
Input power:	4.6VA	
Display:	LCD 2 x 16 characters, backlit	
Size	DN 10÷400	
Lining material	rubber (hard, soft, certif. for potable water): DN25÷400 (up to 80°C) PTFE: DN 15÷DN 250 (up to 150°C) E-CTFE, FEP, PFA: DN 300÷DN 400 (do 130°C) ceramics: DN 15÷DN80 (up to 170 °C)	
Electrode material	CrNi steel DIN 1.4571, Hastelloy C4, Titanium, Tantalum	
Construction	all-welded frame	
Sensor material	flanged – stainless steel and structural steel with polyurethane coating sandwich, threaded, food processing – stainless steel	
Process connection	sandwich flanged DIN (EN1092) threaded (EN ISO 228-1) food processing (fittings DIN 11851, clamp)	
Measuring range (Qmin/Qmax)	0.2÷12 m/s (1/60); 0.12÷12 m/s (1/100); 0.06÷12 m/s (1/200)	
Flow meter accuracy	up to 0.5 % (for 0.1 ÷ 10 m/s)	
Repeatability	up to 0.2 % (for 0.1 ÷ 10 m/s)	
Additional electrodes	reference, earthing and detection for empty pipeline (DN 15÷DN 400)	
Empty pipeline detection	DN 15÷DN 400	
Min. conductivity of medium	20 µS/cm (at a lower conductivity upon agreement with manufacturer)	
Displayed values:	flow – m ³ /h; L/h; L/min; L/s; positive, negative volume – m ³ ; L; positive, negative, sum in both directions	
Controls	2× external button (START / STOP) 3× internal button (viewing + parameter modification)	
Inputs:	buttons START / STOP	
Outputs	impulse/flowswitch (max. 400 Hz, passive),	
Communication:	RS485 (M-BUS/Mod-Bus protocol)	
Sampling:	12.5 samples per second	
Display response:	1.28 s	
Design	separate (standard cable length 3 m)	
Pressure loss	negligible	
Pressure	PN10, PN16, PN25, PN40	
Cable entries	LH (mains) 1 x cable max.φ 9 mm RH (outputs) 1 x cable max.φ 7 mm	
Ambient temperature	5 ÷ 55°C	
Ambient humidity	max. 90%	
Head size	220 x 170 x 80 mm (H x W x D),	
Weight	2540 g (evaluation unit in detached version)	
Material	ABS plastic	
Max. ambient temperature	55 °C	
Flow sensor protection	IP65, IP67, IP68	

If you do not find your size or structure in the Flow sensor technical parameters Table, it is a special or non-standard design. In this case, find the information on the sensor nameplate where this information is always indicated, or please contact the manufacturer for more detailed information.

Error limits at reference conditions (range 1:1000)

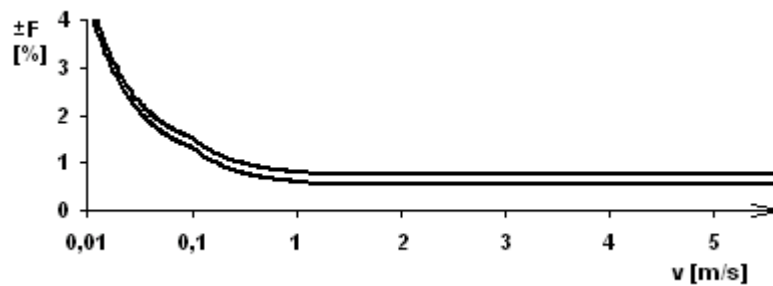

Diameter nominal	Measured value maximum error			Curve
	v ≥ 1 m/s	1 m/s > v ≥ 0.1 m/s	v < 0.1 m/s	
DN [mm]				
≤ DN 10	0.8 % z M*	0.72 % + 0.8 mm/s	1.17 % + 0.35 mm/s	1
≥ DN 15	0.6 % of M*	0.52 % + 0.8 mm/s	0.97 % + 0.35 mm/s	2

* Of M – of the measured value

Factory settings

The address of the meter is set to 1 by default and communication parameters to 2400Bd,8db,1sb,parity EVEN (Mbus) or 9600Bd,8db,1sb, no parity (Modbus).

Access password (PIN) for parameter changing is always set to **0000** and this value will be reset in case of restoring to factory default settings.

Impulse constants – factory settings

Diameter nominal DN	Impulse output	
	Vout[imp/l]	Vout - pulse width [ms]
6	10	4
8	10	4
10	10	4
15	10	4
20	10	4
25	10	4
32	1	4
40	1	4
50	1	4
65	1	4
80	1	4
100	0.1	4
125	0.1	4
150	0.1	4
200	0.1	4
300	0.1	4
400	0.1	2.5

Diameter nominal	Resolution V	Resolution Q
DN≤15	V [0.001 m3]	Q [0.001 m3/h]
50≥DN>15	V [0.01 m3]	Q [0.01 m3/h]
DN>50	V [0.1 m3]	Q [0.1 m3/h]

Table with flow ranges for individual DN sizes

Diameter nominal [mm]	Qmin [m3/h] as per Qmin /Qmax			Qmax [m3/h] (12 m/s)
	1/60 (0.2 m/s)	1/100 (0.12 m/s)	1/200 (0.06 m/s)	
DN 10	0.06	0.034	—	3.4
DN 15	0.13	0.076	0.038	7.6
DN 20	0.24	0.142	0.071	14.2
DN 25	0.35	0.21	0.105	21
DN 32	0.6	0.34	0.17	34
DN 40	0.9	0.54	0.27	54
DN 50	1.4	0.84	0.42	84
DN 65	2.4	1.44	0.72	144
DN 80	3.6	2.2	1.1	220
DN 100	5.6	3.4	1.7	340
DN 125	8.9	5.34	2.67	534
DN 150	13	7.6	3.8	760
DN 200	23	13.5	6.75	1350
DN 250	35	21.1	—	2115
DN 300	51	30	—	3050
DN 350	70	41	—	4150
DN 400	90	54	—	5426

Basic sensor sizes

Threaded design

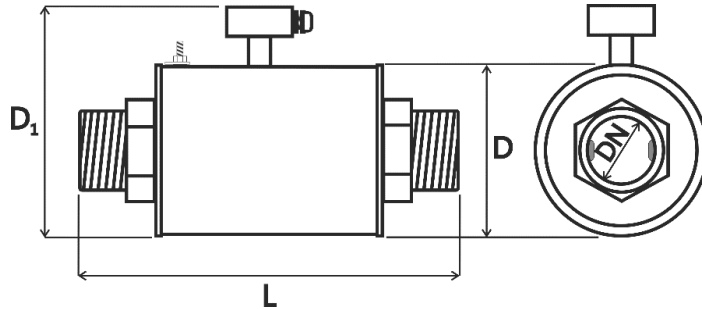

Diameter nominal [mm]	Threaded connection	D External Ø sensors	L Building length of sensor	D1 Building height of sensor	Weight of detached flow sensor (kg)	D2 Building height of comp. meter	Compact flow meter weight (kg)
10, 15	½"	69	133	188	4	275	5
20	¾"	79	141	194	4	281	5
25	1"	89	147	204	5	291	6
32	1 ¼"	99	155	210	5	297	6
40	1 ½"	115	175	232	6	319	7

The Table is for PN25.

Inter-flanged design

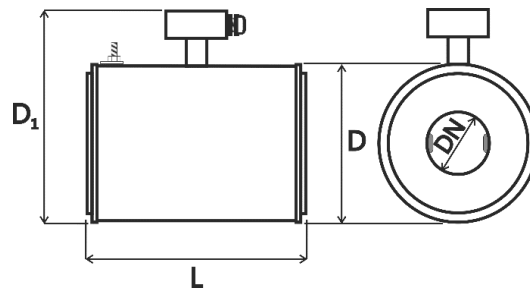

Diameter nominal [mm]	D Outside diameter of sensor	L Building length of sensor	D1 Building height of sensor	Weight of detached flow sensor (kg)	D2 Building height of comp. meter	Compact flow meter weight (kg)
10*,15	51	90	110	2	195	3
20	61	90	120	2	205	3
25	71	90	130	3	215	4
32	82	90	140	3	226	4
40	92	110	150	4	236	5
50	107	110	165	4	251	5
65	127	130	185	5	271	6
80	142	130	200	6	286	7
100	168	200	226	7	312	8
125	194	200	253	9	338	10
150	224	200	283	11	368	12

The Table is for PN25.

* Process connection is performed through DN 15 flange

Flanged design

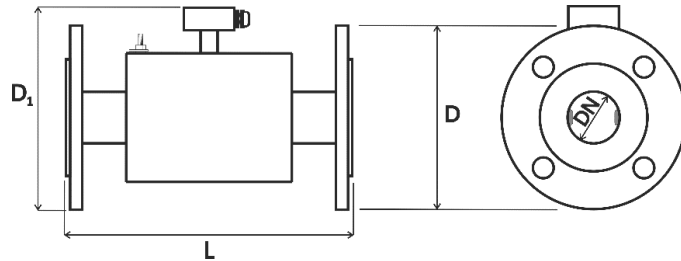

Diameter nominal [mm]	D Outside diameter of flanges	L Building length of sensor	D1 Building height of sensor	Weight of detached flow sensor (kg)	D2 Building height of comp. meter	Compact flow meter weight (kg)
10*,15	100	200	140	4	230	5
20	110	200	150	4	240	5
25	120	200	160	5	250	6
32	140	200	175	6	265	7
40	150	200	185	7	275	8
50	165	200	215	9	300	10
65	185	200	235	11	320	12
80	200	200	250	12	335	13
100	220	250	275	19	360	20
125	250	250	305	26	390	27
150	285	300	335	37	420	38
200	340	350	395	44	480	45
250	410	450	475	65	560	66
300	445	500	520	78	605	79
350	505	550	580	88	660	89
400	570	600	640	106	725	107

The Table is up to DN 200 for PN25, DN250 and DN300 for PN16, DN350 and DN400 for PN10.

* Process connection is performed through DN 15 flange

Food industry design

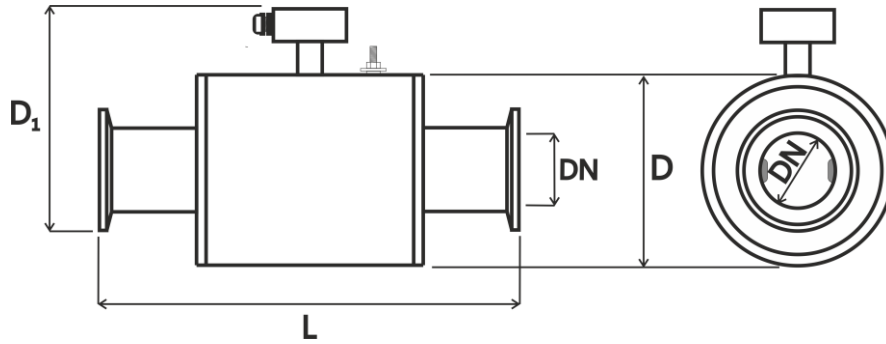

Diameter nominal [mm]	Food grade connection CLAMP/Screwed fitting	D External Ø sensors	L Building length of CLAMP	L Building length of food grade screwed fitting	D1 Building height of sensor	Weight of detached flow sensor (kg)	D2 Building height of comp. meter	Compact flow meter weight (kg)
10, 15	DN 15	69	161	133	188	4	275	5
20	DN 20	79	161	139	194	4	281	5
25	DN 25	89	169	149	204	5	291	6
32	DN 32	99	169	155	210	5	297	6
40	DN 40	115	189	177	232	6	319	7
50	DN 50	135	193	181	236	7	323	8
65	DN 65	150	229	211	266	9	353	10
80	DN 80	176	229	221	276	10	363	11

The Table is for PN25.

Diameter nominal [mm]	DN 15 ÷ DN 20	DN 25 ÷ DN 40	DN 50	DN 65	DN 80
Outside dimension of CLAMP [mm]	34	50,5	64	91	106

Nomogram for quick proposal of the measured place

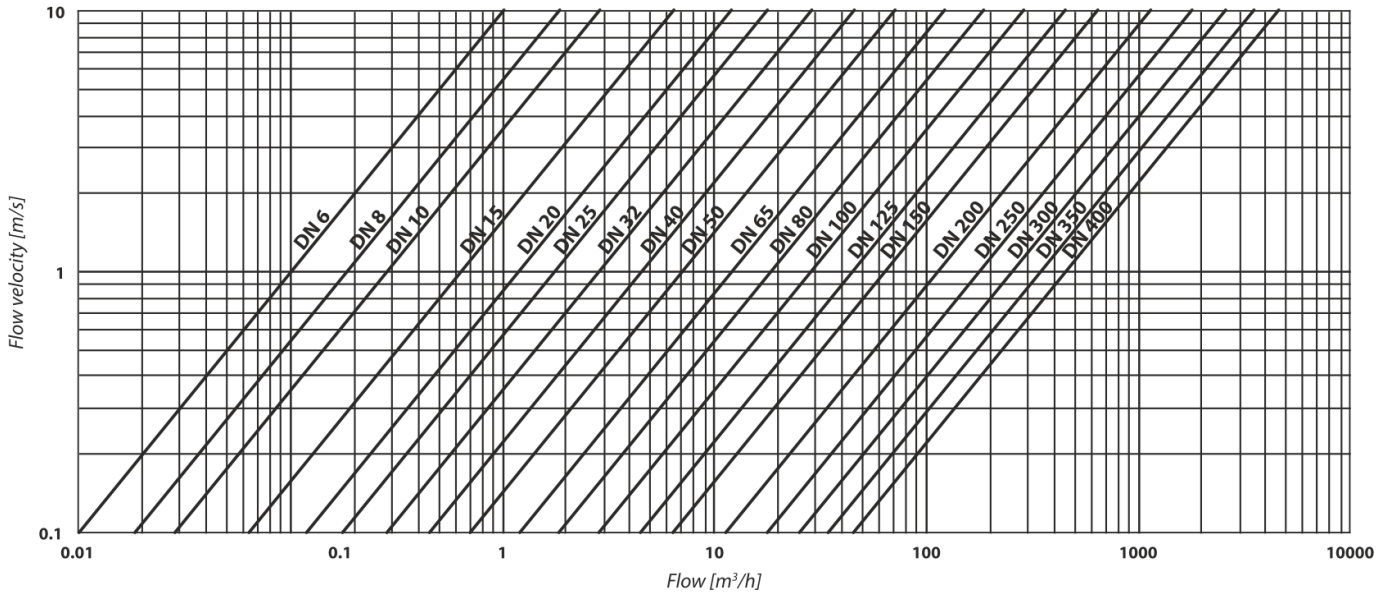

Reduction in DN pipe

If the pipe's DN is higher than that of the meter selected

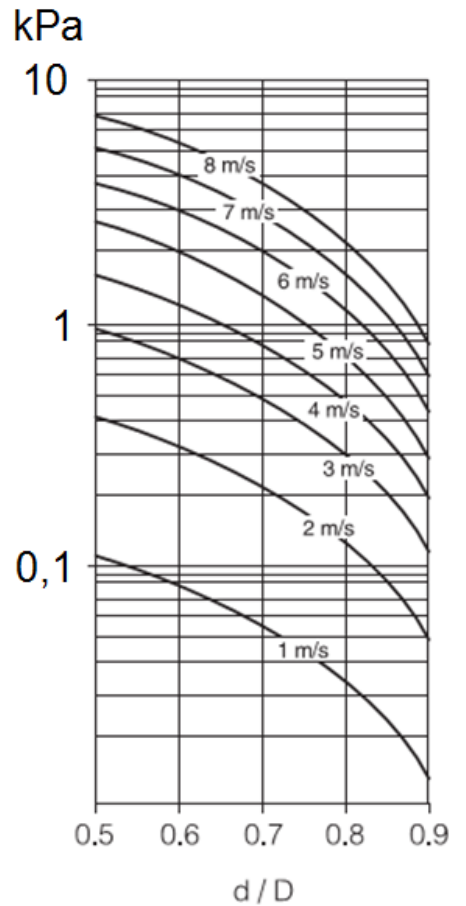
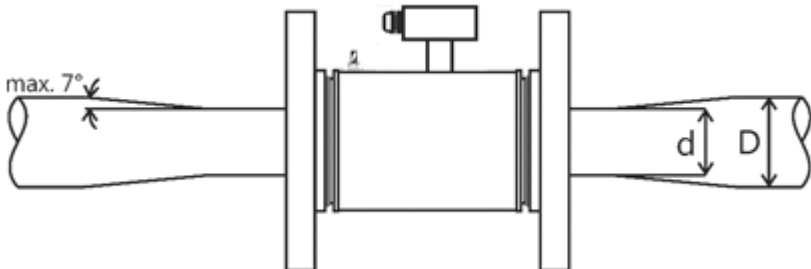

Faults and their symptoms during measurement

Unstable indications and readouts may appear due to:

- big portion of solids
- in homogeneities as a result of the state of matter
- turning point of immixture
- continuous chemical reactions in the measured fluid
- use of diaphragm pumps or plunger pumps
- poor grounding

Flow sensor cleaning

Some measured liquids contain substances and chemicals that tend to form layers inside the pipes including the measuring pipe, which may affect the measurement accuracy. In this case it is necessary to clean the flow sensor from time to time. Ceramic pipes can be cleaned mechanically with a steel brush and then the cleaning can be completed using diluted hydrochloride acid or citric acid solution. The acid removes calcareous layers or black layers of iron complex. If the contamination is greasy, it must be cleaned by caustic soda or potassium hydroxide solution. Flow sensors with teflon, plastic and rubber measuring pipe cannot be cleaned mechanically with a brush, it is only possible to clean them chemically. After cleaning, the pipe must be properly rinsed with water.

Servicing

When the operations described below are carried out incompetently, the claim for warranty for errors resulting from this becomes null and void !!!

Turn off the power every time the evaluation unit is opened !!!

All repairs within warranty and after warranty period are only conducted by the manufacturer,
COMAC CAL s. r.o.

Order code

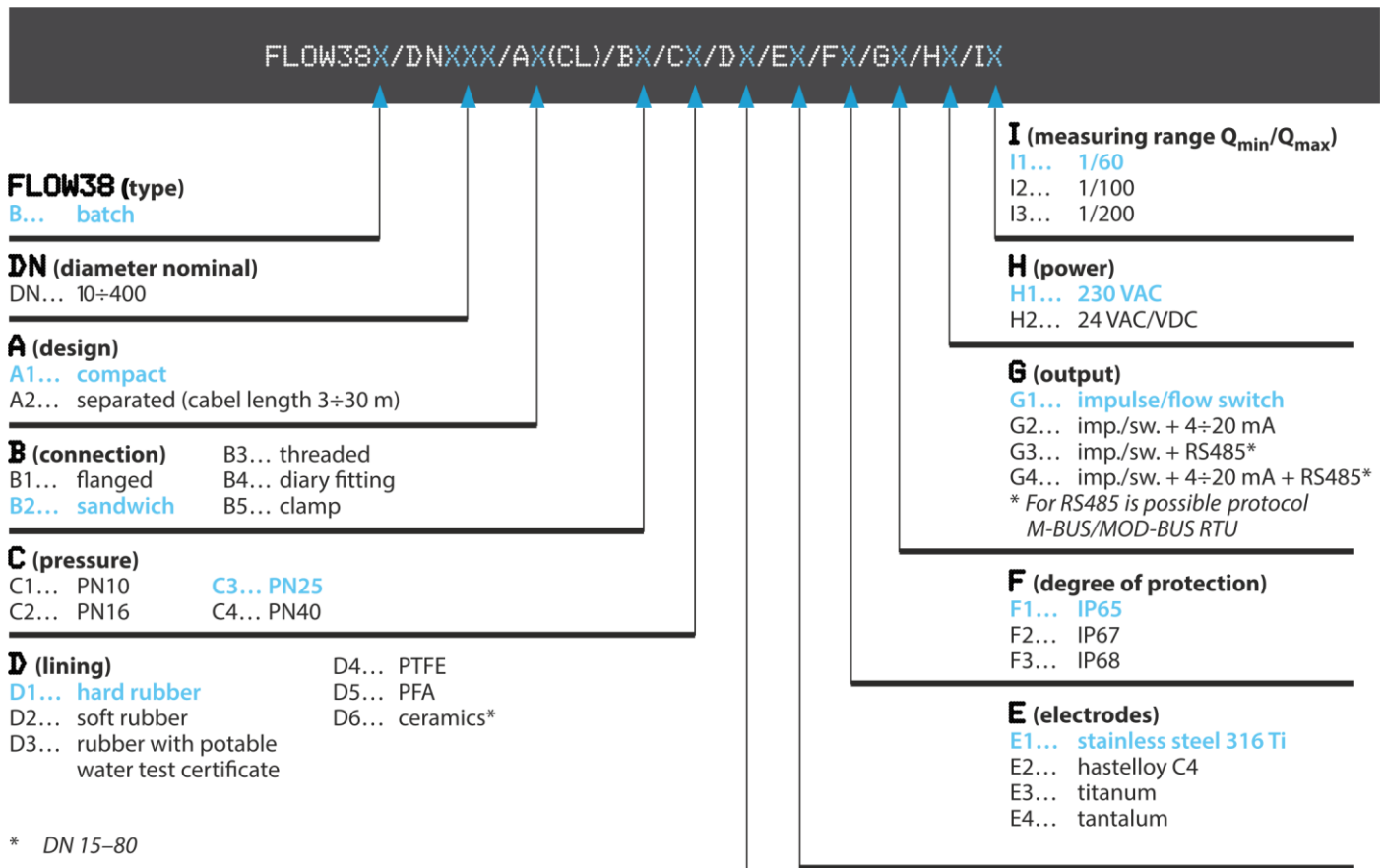

Standard set include installation manual and calibration certificate.
For other requirements, please contact the manufacturer directly.

Form for shipment of the meter back to COMAC CAL s.r.o.

The meter you have was made with the maximum precision and it has been checked many times and wet calibrated.

If the meter is used in agreement with this manual, the occurrence of faults is very rare. Should they ever occur, contact our service department. If you return the meter to the manufacturing plant, adhere to the conditions stated below:

- Clear the meter of contaminations stuck to the sensor and measuring tube (eventually to the Evaluation Unit).
- If the meter was run with poisonous, etching, combustible liquids or with fluids dangerous to water, check it and if appropriate, flush and neutralize the cavities inside the sensor.

Fill in the following data please and the form duly completed attach to your consignment. COMAC CAL s.r.o. will not be able to process your request promptly and correctly without this form.

Customer

Company..... City.....
Department..... Name.....
Phone no.....

Enclosed meter

Type..... Serial number.....
Measured liquid.....

Description of a fault or modifications required.....
.....
.....
.....

We confirm that the meter was duly cleaned, and if required, it was flushed out and neutralized. Therefore, this consignment does not constitute any risk to humans and environment due to remnants of the measured fluid.

Date.....

Signature and stamp.....