

PPM-35

Dinel®

PRESSURE SENSOR

It is designed to measure gaseous and liquid substances in almost all industries.



CE



- **Pressure measurement of gaseous or liquid substances**
- **Easy installation, long service life**
- **Stainless steel housing and diaphragm material**
- **Very good long-term stability**
- **Accuracy 0,5 % of the range**
- **Measuring range up to 100 bar**
- **Relative or absolute pressure measurement**



Technical specifications

Area classification (EN 60079-10-1)	non-explosive areas
Supply voltage	12 ... 34 V DC
Current output	4 ... 20 mA
Voltage output	0 ... 10 V
Permissible overload	1,5x range
Basic accuracy (non-linearity, hysteresis, repeatability)	0,5 % of range
Long-term stability	0,3 % / year
Temperature error for zero and range between 0 ... +50°C	max. 0,04 % / K
Temperature compensation range	0 ... +50 °C
Operating temperature range (media temperature)	-20 ... +85 °C
Operating temperature range, high temperature design (media temperature)	-20 ... 200 °C
Max. load resistance for current output (at U = 24 V DC)	$R_{max} = 600 \Omega$
Protection class	PPM-35_ _ _ _ _ C IP67 PPM-35_ _ _ _ _ (A, B, V, H) IP68
Cable	PVC 2 x 0,75 mm ²
Weight	sensor cca 190 g (according to design) cable (1 m) 60 g

BASIC FEATURES

The **PPM-35 pressure sensor** is a compact measuring device containing a stainless steel strain gauge sensor and evaluation electronics in a stainless steel housing. It is designed for measuring gaseous and liquid substances in almost all industries. Versions for relative and absolute pressure measurement are available. There is also a choice between standard and high temperature versions and a wide range of both process and electrical connections. The maximum measuring range of the sensor is 100 bar. Current or voltage output can be selected as output type.

VARIANTS

code	description
PPM-35N	variant for non-explosion hazardous areas, all stainless steel, various types of process connection, G 1/2", G 1/4", 1/2" NPT, 1/4" NPT, Tri-Clamp 50,5 mm. Electrical connection via fixed cable, M12 connector or ISO connector.
PPM-35NT	variant for non-explosion hazardous areas, high-temperature version. All stainless steel design, process connection G 1/2" and Tri-Clamp 50,5 mm. Electrical connection via fixed cable, M12 connector or ISO connector.

DIMENSIONS

WITHOUT ISO CONNECTOR (WITH CONNECTION METHOD A, B, C, V, H)

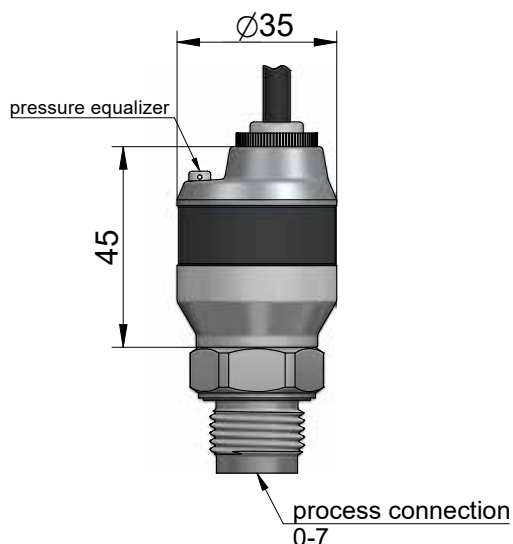

WITH CONNECTOR ISO (G)

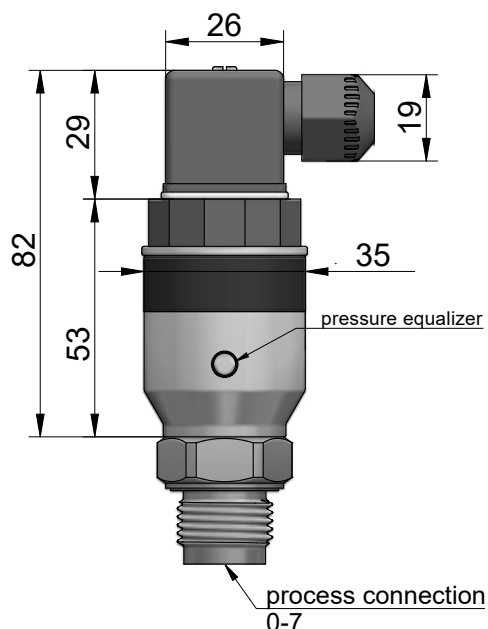

PROCESS CONNECTION

G 1/2" or G 1/4" (DIN 3852)

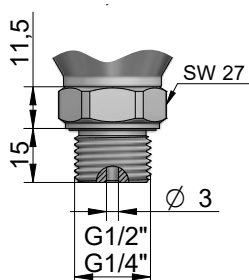

G 1/2" or G 1/4" (EN 837)

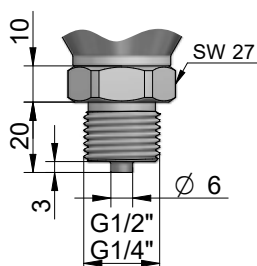

G 1/2" FLUSH MEMBRANE

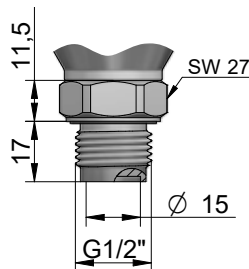

G 1/2" FLUSH MEMBRANE

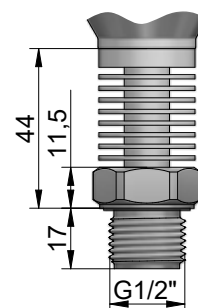

High temperature design

1/2" NPT or 1/4" NPT

TRI-CLAMP
(\varnothing 50,5)

TRI-CLAMP
(\varnothing 50,5)

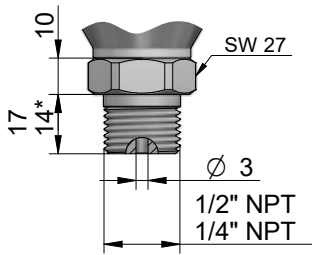

for thread 1/4" NPT

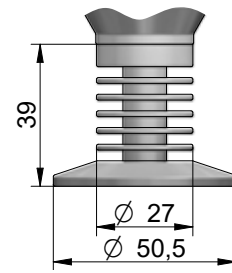
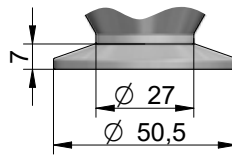

High temperature design

METHOD OF ELECTRICAL CONNECTION

SHORT STAINLESS
STEEL GLAND

PLASTIC THREADED
CABLE GLAND

CONNECTOR M12

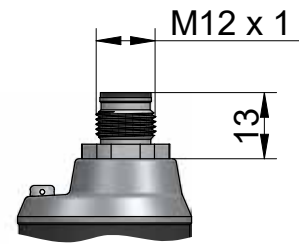
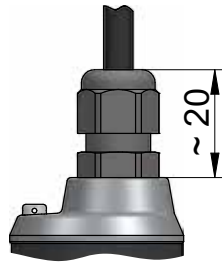
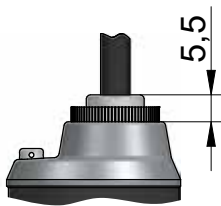

PLASTIC GLAND WITH
SPIRAL RELIEF

CABLE GLAND FOR PROTECTED
HOSE

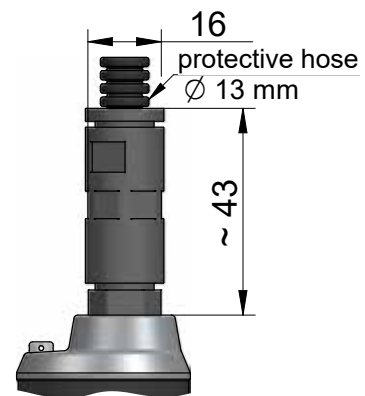
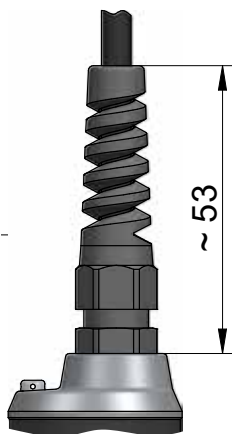

TECHNICAL SPECIFICATIONS

BASIC TECHNICAL DATA

Working environment (EN 60079-10-1)		
Power supply voltage	PPM-35_ _ _ - I	12 ... 34 V DC
Current output	PPM-35_ _ _ - I	4 ... 20 mA
Voltage output	PPM-35_ _ _ - U	0 ... 10 V
Consumption (voltage output at no-load)	PPM-35_ _ _ - U	max. 8 mA
Permissible overload		1,5x range
Basic accuracy (nonlinearity, hysteresis, repeatability)		0,5 % of the range
Long-term stability		0,3 % / year
Temperature error for zero and span in band 0 ... +50 °C		max. 0,04 % / K
Temperature compensation range		0 ... +50 °C
Operating temperature range (medium temperature)		-20 ... +85 °C
Operating temperature range, high temperature design (medium temperature)		-20 ... +200 °C
Max. load resistance of current output (při U = 24 V DC)		R _{max} = 600 Ω
Min. load resistance of voltage output		R _{min} = 1 kΩ
Protection class	type PPM-35_ _ _ - C type PPM-35_ _ _ - (A, B, V, H)	IP67 IP68
Cable	type PPM-35_ _ _ - I-V type PPM-35_ _ _ - U-V	PVC 2 x 0,75 mm ² PVC 3 x 0,5 mm ²
Weight	sensor cable (1 m)	190 g 60 g

MATERIAL USE

part of sensor	type variant	standard material
Head (housing)	all	stainless steel W.Nr. 1.4404 (AISI 316L)
Conclusion	all	stainless steel W.Nr. 1.4301 (AISI 304)
Membrane	PPM-35_ - S	stainless steel W.Nr. 1.4404 (AISI 316L)
Cable gland	PPM-35_ _ _ - A PPM-35_ _ _ - B PPM-35_ _ _ - V PPM-35_ _ _ - H	stainless steel W.Nr. 1.4301 (AISI 304) plastic PA / NBR plastic PA / NBR plastic PA / NBR
M12 connector	PPM-35_ _ _ - C	nickel-plated brass
ISO connector	PPM-35_ _ _ - G	

PROCESS CONNECTION

name	dimension	performance	marking
Tube thread	G 1/2"	DIN 3852	0
	G 1/2"	EN 837	1
	G 1/2"	Flush membrane	2
	G 1/4"	DIN 3852	3
	G 1/4"	EN 837	4
Tubular thread tapered	1/2" NPT	NPT	5
	1/4" NPT	NPT	6
Tri-Clamp	ø 50,5 mm	DIN 32676	7

OPERATING TEMPERATURE RANGES

installation and execution	vertical mounting		
	variant N	variant NT	
ambient temperature	-20 °C ... 85 °C		
media temperature - Flush	-20 °C ... 85 °C	-20 °C ... 150 °C	-20 °C ... 160 °C
media temperature - Tri-Clamp	-20 °C ... 85 °C	-20 °C ... 140 °C	-20 °C ... 150 °C
temperature exposure time	unlimited	unlimited	max. 30 min

installation and execution	vertical mounting		
	variant N	variant NT	
ambient temperature	-10 °C ... 50 °C		
media temperature - Flush	-20 °C ... 85 °C	-20 °C ... 160 °C	-20 °C ... 170 °C
media temperature - Tri-Clamp	-20 °C ... 85 °C	-20 °C ... 150 °C	-20 °C ... 160 °C
temperature exposure time	unlimited	unlimited	max. 30 min

installation and execution	horizontal mounting		
	variant N	variant NT	
ambient temperature	-20 °C ... 85 °C		
media temperature - Flush	-20 °C ... 85 °C	-20 °C ... 160 °C	-20 °C ... 170 °C
media temperature - Tri-Clamp	-20 °C ... 85 °C	-20 °C ... 150 °C	-20 °C ... 160 °C
temperature exposure time	unlimited	unlimited	max. 30 min

installation and execution	horizontal mounting		
	variant N	variant NT	
ambient temperature	-10 °C ... 50 °C		
media temperature - Flush	-20 °C ... 85 °C	-20 °C ... 170 °C	-20 °C ... 200 °C
media temperature - Tri-Clamp	-20 °C ... 85 °C	-20 °C ... 160 °C	-20 °C ... 170 °C
temperature exposure time	unlimited	unlimited	max. 30 min

APPLICATION AREAS

The PPM-35 pressure transmitter is designed for measuring both gaseous and liquid substances in almost all industries. Typical examples of applications are pressure measurement in pressure vessels, ventilation and air conditioning equipment, hydraulic and pneumatic systems. It is possible to measure absolute or relative pressure depending on the sensor design.

MECHANICAL INSTALLATION

The PPM-35 pressure sensor is installed by screwing it into the wall of the tank of the measured space in horizontal, inclined or vertical position. In case there is a risk of various solid particles settling on the bottom of the measured compartment, it is recommended to mount the sensor in a horizontal position to prevent the measurement from being affected by these impurities.

In tanks where swirling of the liquid is caused by a strong inflow or agitator, the probe must be placed in a calming pipe, behind a baffle, or at least as far as possible from the source of swirling.

ELECTRICAL CONNECTION



The electrical connection must only be made in a voltage-free state!

If the sensor is located outdoors at a distance greater than 20 m from an outdoor switchboard or from an enclosed building, the electrical supply to the sensor must be provided with suitable surge protection.

In case of strong ambient electromagnetic interference, concurrence of the supply cable with the power line, or its length greater than 30 m, we recommend using a shielded cable and grounding it on the source side.

The PPM-35 pressure transducer with cable gland type A, B, V, H are connected to the evaluation units with a fixed cable. The PPM-35 pressure transducer with connection type C and G are connected to the evaluation units via a connector socket with crimped cable or via a detachable connector socket without cable (see accessories), the connector is not included in the transducer except for the iso connector. In this case, connect the cable to the internal pins of the socket as shown below.

CONNECTION THROUGH M12 CONNECTOR

The positive pole of the power supply (+U) is connected to the brown wire BN or pin of connector 1, the negative pole (0V) to the blue wire BU or pin of connector 3 and the output voltage (U_{out}) to the black wire BK or pin of connector 4.

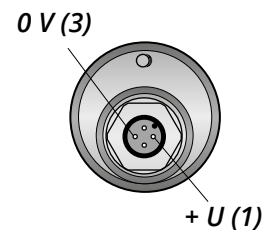
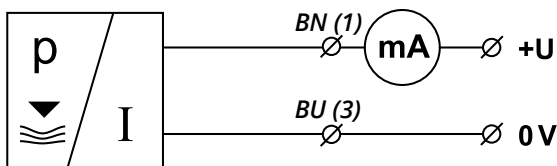

Connection diagram and internal view of the PPM-35 sensor connector (variant I)

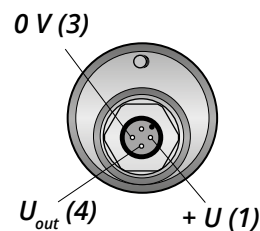
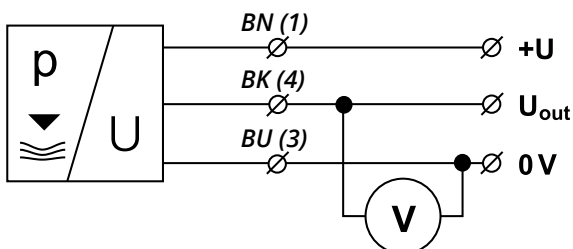

Connection diagram and internal view of the PPM-35 sensor connector (U variant)

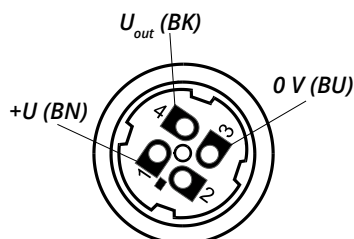
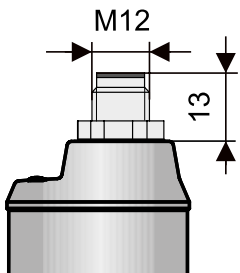

Inner view of the connector drawer variant „C“

explanations:

- (1...) - connector socket terminal numbers
- BN - brown
- BU - blue
- BK - black

CONNECTION THROUGH ISO CONNECTOR

The positive pole of the power supply (+U) is connected to the brown wire BN or pin of connector 1, the negative pole (0 V) to the blue wire BU or pin of connector 2 and the output voltage (U_{out}) to the black wire BK or pin of connector 3.

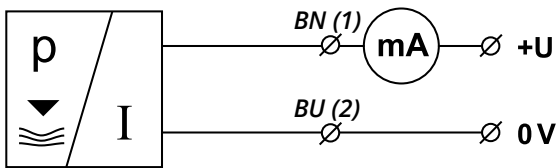

Connection diagram and internal view of the PPM-35 sensor connector (variant I)

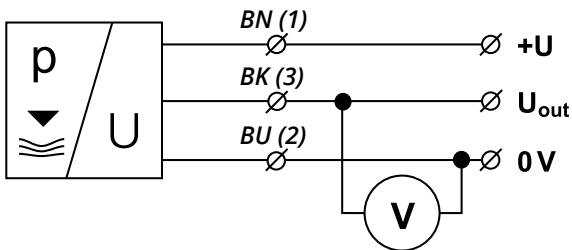
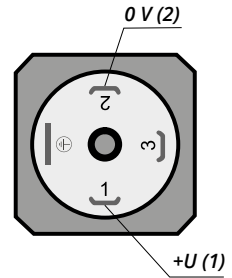

Connection diagram and internal view of the PPM-35 sensor connector (U variant)

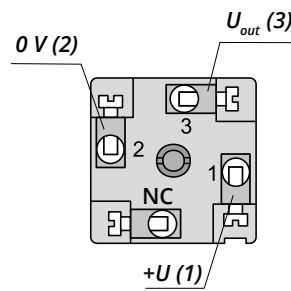
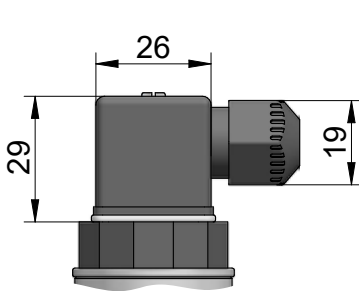
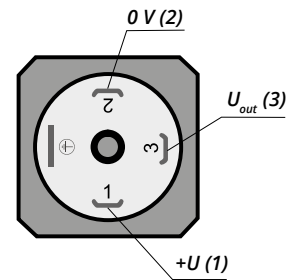

Inner view of the connector drawer variant „G“

explanations:

(1...) - connector socket terminal numbers
 BN - brown
 BU - blue
 BK - black

CONNECTION THROUGH CABLE GLAND

The PPM-35 sensor with electrical connection type A, B or V is connected to the evaluation (display) units with a PVC cable.

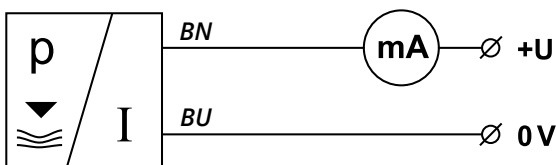

Connection diagram of the PPM-35 sensor fixed cable (I variant)

VERSION „A“
 WITH SHORT
 STAINLESS STEEL GLAND

VERSION „B“
 WITH PLASTIC
 THREADED GLAND

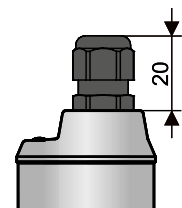
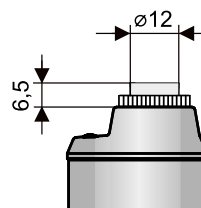

explanations:

(1...) - connector socket terminal numbers
 BN - brown
 BU - blue
 BK - black

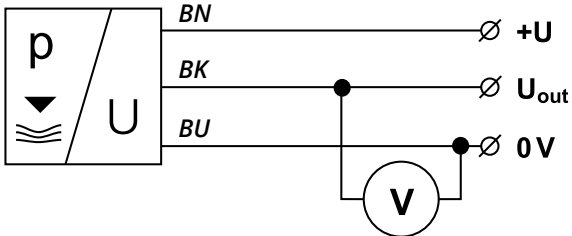

Connection diagram of the PPM-35 sensor fixed cable (U variant)

VERSION „V“
WITH PLASTIC GLAND
WITH SPIRAL RELIEF

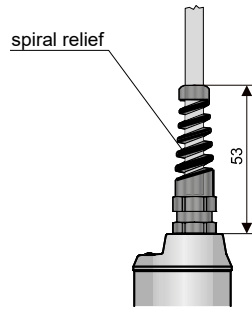

VERSION „H“
GLAND FOR
PROTECTION HOSE

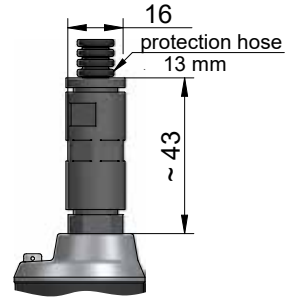

CONNECTION EXAMPLES

CONNECTING THE PPM-35 WITH CURRENT OUTPUT TO THE PDU-4XX-P UNIT (4 ... 20 mA OUTPUT)

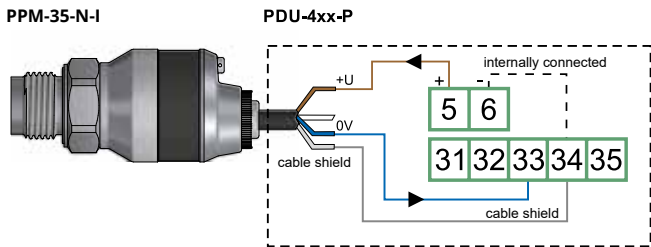

CONNECTING THE PPM-35 WITH CURRENT OUTPUT TO THE PDU-4XX-W UNIT (4 ... 20 mA OUTPUT)

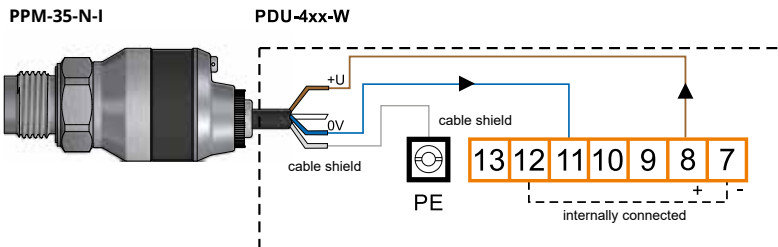

CONNECTING THE PPM-35 LEVEL GAUGE METER CURRENT OUTPUT TO THE PCU-100 (4 ... 20 mA OUTPUT)

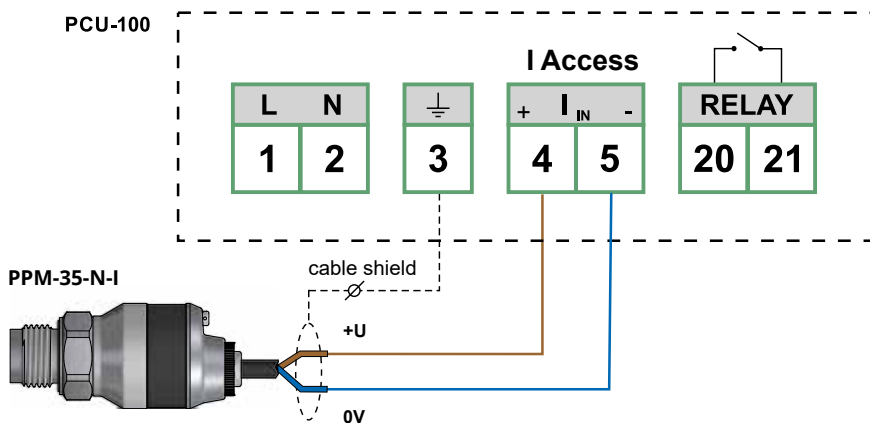

ORDER CODE

PPM-35

PERFORMANCE

N	non-explosion areas
NT	high temperature performance up to 200 °C for G 1/2" Flush membrane and 170 °C for Tri-Clamp ø 50,5

TYPE OF MEMBRANE

S	stainless steel membrane
----------	--------------------------

PROCESS CONNECTION

0	G 1/2" (DIN 3852)
1	G 1/2" (EN 837)
2	G 1/2" Flush membrane
3	G 1/4" (DIN 3852)
4	G 1/4" (EN 837)
5	1/2" NPT
6	1/4" NPT
7	Tri-Clamp (Ø 50,5) Flush membrane

TYPE OF OUTPUT

I	current output (4 ... 20 mA)
U	voltage output (0 ... 10 V)

CONNECTION METHOD

A	stainless steel gland
B	plastic threaded gland
C	M12 connector
G	ISO connector
V	plastic gland with spiral relief
H	gland for protection hose

SET-UP ELEMENTS

L	without adjustment elements
----------	-----------------------------

ACCURACY

0	0,5 % FS
----------	----------

MEASURED PRESSURE

G	relative pressure
A	absolute pressure

MEASURING RANGE PRESSURE [bar]

0000	-1 ... 0
1000	0 ... 0,1
2000	0 ... 0,2
3500	0 ... 0,35
5000	0 ... 0,5
7000	0 ... 0,7
1001	0 ... 1
1601	0 ... 1,6
2501	0 ... 2,5
4001	0 ... 4
6001	0 ... 6
1002	0 ... 10
1602	0 ... 16
2502	0 ... 25
4002	0 ... 40
6002	0 ... 60
1003	0 ... 100

CABLE





K	cable length in m
----------	-------------------

PPM-35 N - S - 0 - I - A - L - 0 - G - 1002

K10

**AVAILABLE
PRODUCT
ALTERNATIVES**

ACCESSORIES

cable (over standard length 2 m)	at extra cost		
connecting connector M12	at extra cost	ELWIKA, ELKA	
ISO connecting connector	included in the price		
protective hose (for cable gland H)	at extra cost		
steel welding flange	at extra cost	NN-G1/2 ON-G1/2	

SAFETY, PROTECTION, COMPATIBILITY AND EXPLOSION PROOF

The PPM-35 sensor is equipped with power supply voltage overvoltage protection, overcurrent protection and short-term overvoltage protection.

Protection against dangerous contact is provided by a small safe voltage according to EN 33 2000-4-41. Electromagnetic compatibility is ensured by compliance with EN 55011 / B, EN 61326-1, EN 61000-4-2, -4-3, -4-4, -4-5 and -4-6.

The manufacturer reserves the right to change the specifications and appearance of the product without prior notice.

Dinel, s. r. o.
U Tescomy 249, 760 01 Zlín, Czech Republic
tel.: +420 577 002 003
email: sale@dinel.cz

www.dinel.cz

version:
2/2023

