



### **LOCAL PROCESS INDICATOR LDU-401**

---



## TABLE OF CONTENTS

---

1. Brief.....	5
2. Dimensional drawing.....	5
3. Installation .....	6
4. Electrical connection.....	6
5. Settings.....	6
6. Accessories .....	9
7. Safety, protection and compatibility.....	9
8. Use, manipulation and maintenance .....	10
9. Specifications .....	10

## USED SYMBOLS

To ensure maximum safety of control processes, we have defined the following safety instructions and information. Each instruction is labeled with the appropriate pictogram.



### **Alert, warning, danger**

This symbol informs you about particularly important instructions for installation and operation of equipment or dangerous situations that may occur during the installation and operation. Not observing these instructions may cause disturbance, damage or destruction of equipment or may cause injury



### **Information**

This symbol indicates particularly important characteristics of the device.



### **Note**

This symbol indicates helpful additional information.

---

## SAFETY



*All operations described in this instruction manual have to be carried out only by trained personnel or an accredited person. Warranty and post warranty service must be exclusively carried out by the manufacturer.*

*The manufacturer is not responsible for improper use, losses of work caused by either direct or indirect damage, and for expenses incurred during installation or use of the Indicator.*

## 1. BRIEF

LDU-401 process indicator is fit for all level meters with 4 ... 20 mA with 2-wire technique. Customer can use the two buttons to program the zero point, span, decimal point, damping and alarm point etc. Over or under range are displayed as a message. The integrated smart diagnostic system continuously monitors all device function. The programmed parameters are stored in an EEPROM and being kept in case of a power failure. The plug-on display is simply plugged in between connector and socket; it is then ready for operation.

## 2. DIMENSIONAL DRAWING

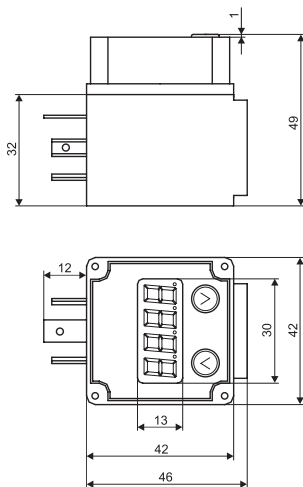

### 3. INSTALLATION

The LDU-401 is simply plugged in between connector plug and socket; it is then ready for operation. The fixing screw must be replaced with the longer screw that is a part of the delivery scope.



Fig. 1: Example for usage with a Dinel level meter ULM

### 4. ELECTRICAL CONNECTION

Positive pole (+ U) is connected to pin No. 1 and negative pole (0 V) is connected to pin No. 2. The plug-on display is powered by the current loop of the 4 to 20 mA, no additional auxiliary power is required.

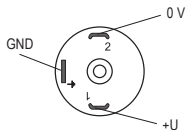





Fig. 2: LDU-401 socket



Electrical connection must be done in de-energized state!

### 5. SETTINGS

After the indicator LDU-401 was connected to the current circle (4 ... 20 mA), you can enter into the interface of display. Button  is for down menu select,  is for up menu select.  +  buttons select menu item for setting or confirmation the setting.

### Zero-point (value to be displayed for 4mA)

- Press button + to select the menu item for setting **SEt2**
- + menu item for setting: **0400** |
- Press button to move the cursore, to change the value that the cursor point to.
- + to confirm and store setting and return to the menu item.

### Span (value to be displayed for 20mA)

- Press button , unit **SEtS** is displayed.
- + menu item for setting: **2000**
- Press button to move the cursore, to change the value that the cursor point to.
- + to confirm and store setting and return to the menu item.







### Decimal point

- Press button , unit **dPt** is displayed.
- + menu item for setting: **-.-.-**
- Press button to move the decimal toward left, to move the decimal toward right.
- + to confirm and store setting and return to the menu item.

### Damping

- Press button , unit **dAP** is displayed.
- + menu item for setting: **2000**
- Press button to move the cursore, to change the value that the cursor point to.  
Min. 0 s; Max 20 s; Step 0,5 s.
- + to confirm and store setting and return to the menu item.

## Alarm





- Press button , unit **H I L o** is displayed.
-  +  menu item for setting: **o F F**
- Press button  or  to change the setting either “on” or “oFF”. “on” means the parameter followed is valid and “oFF” cancel the alarm function.
-  +  to confirm and store setting and return to the menu item.

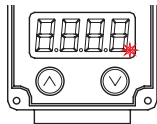





The alarm was expressed by the twinkle of the last decimal point.









### The first alarm point

- Press button , unit **S E P L** is displayed
-  +  menu item for setting.
- It is configured in percentage of span.
-  +  to confirm and store setting and return to the menu item.

### The second alarm point







- Press button , unit **S E P L** is displayed
-  +  menu item for setting.
- It is configured in percentage of span.
-  +  to confirm and store setting and return to the menu item.

### The direction of the first alarm point









- Press button , unit **L d I r** is displayed.
-  +  menu item for setting: **d n**
- Press button  or  to change the setting either “UP” or “dN”. “UP” means alarm while the value change from small to big, and “dN” means alarm while the value change from big to small.
-  +  to confirm and store setting and return to the menu item.



### **The direction of the second alarm point**

- Press button , unit **HdIr** is displayed.
-  +  menu item for setting: **UP**
- Press button  or  to change the setting either “UP” or “dN”. “UP” means alarm while the value change from small to big, and “dN” means alarm while the value change from big to small.
-  +  to confirm and store setting and return to the menu item.

### **Delay**

- Press button , unit **dELR** is displayed.
-  +  menu item for setting.
- Press button  to move the cursore,  to change the value that the cursor point to.
-  +  to confirm and store setting and return to the menu item.
- Press button  to return the original interface. And all setting is completed.

---

## **6. ACCESSORIES**

### **Standard – include in the indicator price**

- 1 pc of fixing screw M3x90
- 1 pc of seal

---

## **7. SAFETY, PROTECTION AND COMPATIBILITY**

The LDU-401 indicator is equipped with protection against reverse polarity and short circuit.

Protection against dangerous contact is secured by low safety voltage that complies with EN 33 2000-4-41.

Electromagnetic compatibility according to EN 50081-2 and EN 50082-2.

## 8. USE, MANIPULATION AND MAINTENANCE

The indicator does not require any personnel for its operation. Maintenance of this equipment consists in verification of integrity of the indicator socket and of the supply cable. In case any visible defects are discovered, the manufacturer or reseller of this equipment must be contacted immediately.



It is forbidden to perform any modifications or interventions into the LDU-401 indicator without manufacturer's approval. Potential repairs must be carried out by the manufacturer or by a manufacturer authorized service organization only.

Installation, commissioning, operation and maintenance of the LD-401 has to be carried out in accordance with this instruction manual; the provisions of regulations in force regarding the installation of electrical equipment have to be adhered to.

## 9. SPECIFICATIONS

TECHNICAL DATA	
Input signal	4 ... 20mA
Voltage drop	< 2.5V
Accuracy	0.1% ± 1 digit
Display	4 digit LED, height of digit 7 mm
Ambient temperature range	-20 ... +70°C
Storage temperature range	-30 ... +85°C
Connection	Connector acc. to DIN 43 650
Housing	plastic ABS
Protection class	IP65
Dimension	42 x 46 x 49 mm (š v h)
Weight	approx. 80 g



# Dinel<sup>®</sup>

industrial electronics

**Dinel, s.r.o.**

U Tescomy 249  
760 01 Zlín  
Czech Republic

Tel.: +420 577 002 003

Fax: +420 577 002 007

E-mail: [sale@dinel.cz](mailto:sale@dinel.cz)

[www.dinel.cz](http://www.dinel.cz)

The latest version of this instruction manual can be found at [www.dinel.cz](http://www.dinel.cz)

Version: 05/2012



QMS  
ISO 9001

